

# STILLE Surgical Instruments



I över 170 år har vi utvecklat och tillverkat de bästa kirurgiska instrumenten till världens mest krävande kirurger. Vi vill rikta ett stort tack till alla våra trogna kunder och samtidigt välkomna våra nya kunder. I den här katalogen presenterar vi vårt nya sortiment som är indelat i tre huvudkategorier; det klassiska, det ortopediska samt instrument lämpliga för plastikkirurgi.

### STILLE CLASSIC

Det klassiska sortimentet är vår bas, vår över 170-åriga historia, vår ryggrad. Här hittar du våra saxar, allt från vanliga operationssaxar till våra unika SuperCut-saxar. Du hittar även STILLES klassiska pincetter, våra eleganta nålförare, peanger, klämmare, tänger, kyretter och hakar samt mikroinstrument. Gemensamt för instrumenten är att de alla är smidiga med lätt gång. Deras balans, eleganta utformning och ergonomi möjliggör långa och komplicerade ingrepp med största säkerhet. Instrumenten tillverkas för hand i vår unika smidesprocess av våra skickliga instrumentmakare med den kvalitet och fingertoppskänsla som STILLE är känd för.

### ORTOPEDISK KIRURGI

För krävande ortopedier kan vi nu erbjuda ett starkt och brett sortiment. Det rymmer allt från gougetänger, osteotomer, hakar, slevor och raspatorier till hammare. Fortfarande är vi mest stolta över att ha utvecklat den första dubbelledade gougetången (sid 93-99). Vi uppfann även världens första osteotom med det klassiska 8-kantiga handtaget (sid 172). Båda har sedan dess kopierats, men en kopia kan aldrig mäta sig med originalet.

### PLASTIKKIRURGI

Vi har spetsat sortimentet med många nya instrument för plastikkirurgi. De klarar de flesta ingrepp inom såväl rekonstruktiv som kosmetisk plastikkirurgi. Mikroinstrument och Facelift-saxen är bara ett par exempel. Kännetecknen för STILLES instrument är att de är lätta och gracila och fungerar perfekt under ingrepp som kräver extrem precision. Instrumenten blir en naturlig förlängning av kirurgens hand. Alltid med ett perfekt resultat.



For over 170 years, we have developed and manufactured the best surgical instruments for the world's most demanding surgeons. We would like to extend a heartfelt thank you to all our loyal customers and a warm welcome to our new customers. In this catalog we present our new product range that is now divided into three main categories: classic, orthopedic and instruments suitable for plastic surgery.

### STILLE CLASSIC

The classic category is our base, and has been our backbone throughout our 170 year history. Here you will find our line of scissors, everything from common surgical models to our unique SuperCut scissors. You'll also find STILLE classic forceps, our elegant needle holders, artery forceps, clamps, rongeurs, curettes and retractors as well as micro instruments. Common to all of our instruments is that they are smooth and easy to operate. Their outstanding balance, elegant design and ergonomics allow long and complex procedures with the utmost security. Using our own unique forging process, our skilled craftsmen handcraft every instrument and provide the high quality and fingertip feeling that STILLE is known for.

### ORTHOPEADIC SURGERY

For demanding orthopedic surgeons, we offer an outstanding range of instruments. The assortment includes everything from bone rongeurs, osteotomes, retractors, curettes and scrapers to hammers. We are still proud to have developed the first double-action bone rongeur (pp. 93-99). We also invented the world's first osteotome with the classic 8-sided handle (page 172). Both instruments have since then been copied, but a copy can't measure up to the original.

### PLASTIC SURGERY

We have added many new instruments for plastic surgery. These instruments can handle most procedures in the field of reconstructive and cosmetic surgery. Micro Instruments and Facelift-scissors are just two examples. STILLE instruments are known to be light and graceful and to function perfectly during procedures requiring extreme precision. The instruments become a natural extension of the surgeon's hand – and the result is always perfect.

# Innehåll | Table of contents | Inhaltsverzeichnis | Indice | Tabla de contenido | 目次

## 12 Saxar | Scissors | Scheren | Forbici | Tijeras | 剪刀 (はさみ)

- 16 Ögonsaxar | Eye Scissors | Augenscheren | Forbici oculistiche | Tijeras oculares | 眼科剪刀
- 17 Ögonlockssaxar | Blepharoplasty Scissors | Blepharoplastik-Scheren | Forbici per blefaroplastica | Tijeras de Blefaroplastia | 眼瞼形成用剪刀
- 18 Dissektionssaxar | Dissecting scissors | Präparierscheren | Forbici da dissezione | Tijeras para disección | 剥離・切離用剪刀
- 28 Operationssaxar | Operating scissors | Chirurgische Scheren | Forbici chirurgiche | Tijeras para cirugía | 外科剪刀
- 31 Tenotomisaxar | Tenotomy scissors | Sehenscheren | Forbici per tenotomia | Tijeras para tenotomía | 腱切除用剪刀
- 33 Kärlsaxar | Vascular scissors | Gefäßscheren | Forbici vascolari | Tijeras vasculares | 血管剪刀
- 34 Nässaxar | Nasal scissors | Nasenscheren | Forbici nasali | Tijeras nasales | 鼻用剪刀
- 38 Face-lift saxar | Face-lift scissors | Face-lift Scheren | Forbici face-lift | Tijeras face-lift | フェイスリフト用剪刀
- 41 Trådföringssaxar | Suture carrying scissors | Fadenführungsscheren | Forbici portafilo | Tijeras portahilos | 縫合糸保持剪刀
- 42 Sutursaxar | Suture scissors | Fadenscheren | Cesioie per suture | Cizallas para suturas | 抜糸用剪刀

## 44 Pincetter | Forceps | Pinzetten | Pinze | Pinzas | 鑷子 (ピンセット)

- 46 Pincetter | Forceps | Pinzetten | Pinze | Pinzas | 鑷子 (ピンセット)
- 49 Anatomiska pincetter | Dressing forceps | Anatomische Pinzetten | Pinze anatomiche da dissezione | Pinzas de disección | 包帶鑷子
- 51 Durapincetter | Dura forceps | Durapinzetten | Pinze per dura madre | Pinzas para dura-madre | 硬膜鑷子または5爪鑷子
- 52 Irispincetter | Iris forceps | Irispinzetten | Pinze per iride | Pinzas para iris | 眼科鑷子
- 53 Kärlpincetter | Vascular forceps | Gefäßspinzetten | Pinze vascolari | Pinzas vasculares | 血管鑷子
- 54 Diatermipincetter | Diathermy forceps | Diathermiepinzetten | Pinze per diatermia | Pinzas para diatermia | ジアテルミー鑷子
- 55 Knutpincetter | Knot-holding forceps | Knüpfpinzetten | Pinze per nodi | Pinzas para nudos | 結び目保持鑷子

## 56 Peanger | Artery forceps | Arterienklemmen | Pinze emostatiche | Pinzas hemostáticas | 止血鉗子

- 58 Peanger | Artery forceps | Arterienklemmen | Pinze emostatiche | Pinzas hemostáticas | 止血鉗子
- 70 Artär- och ligaturklämmare | Artery and ligature clamps | Arterien- und Ligaturklemmen | Pinzas per arterie e legature | Pinzas para arterias y ligaduras | 結紮鉗子および剥離鉗子

## 72 Nålförare | Needle holders | Nadelhalter | Portaghi | Porta-agujas | 持針器

- 74 **Nålförare storlekstabell** | Needle holder in relation to suture size | Nadelhalter in Relation zur Stärke des Nahtmaterials | Il portaaghi in relazione alla misura della sutura | Porta-agujas en relación al tamaño de la sutura | 縫合糸サイズに適する持針器
- 75 **Nålförare** | Needle holders | Nadelhalter | Portaghi | Porta-agujas | 持針器
- 84 **Knuthållartänger** | Knot-holding Forceps | Knüpfzangen | Pinze portanodi | Pinzas para atar nudos | 結び目保持鉗子
- 85 **Ståltrådsroterare & hållare** | Wire Twisting & Holding Forceps | Draht-Dreh- und Haltezange | Pinza serra-fili | Pinzas cierra-hilos y pinzas para extraer alambres | ワイヤークルップ

## 86 Bentänger | Bone cutters and rongeurs | Knochen & hohlmeisselzangen | Cesoié per ossa & pinze sgorbie | Pinzas cortantes & pinzas-gubias | 骨剪刀および骨鉗子(ロンジュール)

- 88 **Platttänger** | Flat pliers | Flachzangen | Tenaglia piatta | Alicates planos | ペンチ(シングルアクション)
- 89 **Extraktionstänger** | Extraction pliers | Extraktionszangen | Pinze d'estrazione | Pinzas de extracción | ペンチ(ダブルアクション)
- 90 **Benavbitare** | Bone cutting forceps | Knochensplitterzangen | Cesoié per ossa | Pinzas cortantes | 骨切り鉗子
- 92 **Gougetänger** | Bone rongeurs | Hohlmeisselzangen | Pinze-sgorbie | Pinzas-gubias | 骨鉗子(ロンジュール)
- 100 **Benhållartänger** | Bone holding forceps | Knochenhalte-zangen | Tenaglie per ossa | Pinzas para hueso | 骨保持鉗子
- 101 **Trådavbitare** | Wire cutters | Drahtkneifzangen | Tenaglie tagliafili | Alicates corta-alambres | ワイヤークッター
- 103 **Laminektomistansar** | Laminectomy punches | Laminektomiestanzen | Pinze taglienti per laminectomia | Pinzas cortantes para laminectomía | 椎弓切除用パンチ(ケリソパンチ)
- 105 **Bittänger** | Rongeurs for intervertebral discs | Bandscheiben-Rongeur | Pinze taglienti per dischi intervertebrali | Pinzas cortantes para discos intervertebrales | 骨鉗子(ボーンロンジュール)

## 108 Klämmare | Clamps | Klemmen | Pinze | Pinzas | 血管鉗子および組織把持鉗子

- 110 **Colonklämmare** | Colon Clamps | Colonklemmen | Pinze per colon | Pinzas para colon | 結腸鉗子
- 111 **Galltänger** | Gall duct clamps | Gallenkanalklemmen | Pinze per vie biliari | Pinzas para conductos biliares | 胆管クランプ
- 112 **Universalklämmare** | Multi-purpose clamps | Mehrzweckklemmen | Pinze per applicazione universale | Pinzas de múltiple uso | 多目的クランプ
- 115 **Tangential occlusionsklämmare** | Tangential occlusion clamps | Tangential-Verschlussklemmen | Pinze per occlusione tangenziale | Pinzas tangentes de oclusion | 正接鉗子
- 117 **Perifera kärlklämmare** | Peripheral vascular clamps | Peripheralklemmen | Pinze per vasi periferici | Pinzas para vaso periférico | 末梢血管クランプ
- 118 **Anastomosklämmare** | Anastomosis clamps | Anastomosenklemmen | Pinze per anastomosi | Pinzas para anastomosis | 吻合クランプ
- 119 **Aorta anastomosklämmare** | Aortic-anastomosis clamps | Aorten-Anastomosenklemmen | Pinze per anastomosi dell'aorta | Pinzas para anastomosis aórtica | 大動脈吻合クランプ

- 120 **Aorta-aneurysmklämmare** | Aortic-aneurysm clamps | Aorten-Aneurysmenklemmen | Pinze per aneurisme aortiche | Pinzas de aneurisma aórtica | 大動脈瘤クランプ
- 121 **Carotisklämmare** | Carotid clamps | Carotisklemmen | Pinze carotidee | Pinzas para carótida | 頸動脈クランプ
- 122 **Profunda arteria femoralis klämmare** | Profunda femoral artery clamps | Profunda Arteria Femoralis Klemmen | Pinze per arteria femorale profunda | Pinzas para arteria femoral profunda | 大腿深動脈クランプ
- 123 **Dukklämmare** | Towel clamps | Tuchklemmen | Fissatele | Pinzas de campo | タオル鉗子
- 124 **Fattningstånger** | Intestinal grasping forceps | Darmfasszangen | Pinze per afferrare l'intestino | Pinzas para coger intestinos | 腸管把持鉗子
- 127 **Ringtänger** | Sponge holding forceps | Schwammzangen | Pinze per spugne | Pinzas para esponjas | スポンジ鉗子
- 129 **Klotånger** | Tenaculum forceps | Hakenzangen | Pinze per il collo dell'utero | Pinzas para coger el cuello del útero | 子宮支持鉗子 スポンジ鉗子

## 132

### Hakar | Retractors | Wundhaken | Divaricatori | Separadores | 開創器、鉤、レトラクター

- 134 **Hudhakar** | Skin hooks | Hauthäkchen | Uncini cutanei | Ganchos para piel | スキンフック
- 136 **Nervhakar** | Nerve hooks | Nervhäkchen | Uncini per nervi | Ganchos para nervios | 神経鉤
- 137 **Hakar** | Retractors | Wundhaken | Divaricatori | Separadores | 鉤(レトラクター)
- 145 **Bukhakar** | Abdominal retractors | Bauchdeckenhaken | Divaricatori addominali | Separadores abdominales | 開腹鉤
- 147 **Bukspatlar** | Abdominal spatulas | Bauchspatel | Spatole addominali | Espátulas abdominales | 腸ペラ
- 148 **Tracheotomihakar** | Trachea retractors | Trachealhaken | Divaricatori tracheali | Separadores para traquea | 気管支用レトラクター
- 149 **Självhållande hakar** | Self retaining retractors | Selbsthaltende Wundhaken | Autostatici divaricatori | Retención automática separadores | 開創器
- 151 **Revbensspridare** | Rib spreaders | Rippenspreizer | Divaricatori costali | Separadores costales | 開胸器
- 152 **Nässpekulum** | Nasal Specula | Nasenspekula | Speculi nasali | Espéculos nasales | 鼻鏡(スペキュラ)

## 154

### Slevar, Raspatorier, Elevatorier etc. | Curettes, Raspatories, Elevators etc. | Löffel, Raspatorien, Elevatorien etc. | Curette, Staccaperiostio, Elevatori etc. | Cucharillas, Legras, Elevadores etc. | 鋭匙、やすり 骨膜起子

- 156 **Uteruskyretter** | Uterine curettes | Uterusküretten | Curette uterine | Curetas uterinas | 子宮鋭匙
- 157 **Slevar** | Bone curettes | Löffel | Curette | Cucharillas | 骨鋭匙
- 158 **Raspatorier** | Raspatories | Raspatorien | Staccaperiostio | Legras | 骨膜剥離子
- 163 **Elevatorier** | Elevators | Elevatorien | Elevatori | Elevadores | 骨膜起子
- 167 **Dissektorer** | Dissectors | Dissektoren | Dissettori | Disecadores | 剥離子
- 168 **Raspar** | Rasps | Raspeln | Raspe | Escofnas | 骨やすり

## 170 Osteotomer, mejslar etc. | Osteotomes, Chisels etc. | Osteotome, Flachmeissel etc. | Osteotomi, Scalpelli etc. | Escoplos, Cinceles etc. | 両刃のみ 片刃のみ

172 **Osteotomer** | Osteotomes | Osteotome | Osteotomi | Escoplos | 両刃のみ

179 **Mejslar** | Chisels | Flachmeissel | Scalpelli | Cinceles | 片刃のみ

180 **Gougemejslar** | Gouges | Gouges | Sgorbie | Gubias | 丸刃のみ

181 **Prylar** | Awls | Pfrieme | Lesine | Escariadores | 穿孔器

182 **Hammare** | Mallets | Hämmer | Martelli | Martillos | 槌

## 184 Mikroinstrument | Micro instruments | Mikro-instrumente | Strumenti per microchirurgia | Instrumentos para microcirugia | マイクロ器具

188 **Mikrosaxar** | Micro scissors | Mikroscheren | Mikro forbici | Micro tijeras | マイクロ剪刀

190 **Mikropincetter** | Micro forceps | Mikropinzetten | Micro pinze | Micro pinzas | マイクロ鑷子

192 **Mikronålförare** | Micro needle holders | Mikronadelhalter | Micro portaghi | Micro porta-agujas | マイクロ持針器

## 194 Övriga instrument | Various instruments | Sonstige Instrumente | Altri strumenti | Instrumentos varios | 様々な器具

198 **Övriga instrument** | Various instruments | Sonstige Instrumente | Altri strumenti | Instrumentos varios | 様々な器具

205 **Implantat & instrument** | Implants & instruments | Implantate & Instrumente | Implantati & strumenti | Implantés & instrumentos | インプラントおよび器具

## 209 Register | Index | Verzeichnis | Indice | Índice | 索引

209 **Numeriskt index** | Numerical index | Nummernverzeichnis | Indice di numeri | Indice de números | 品番索引

213 **Alfabetiskt register** | Alphabetical index | Alphabetisches Inhaltsverzeichnis | Indice alfabetico | Índice alfabético | アルファベット索引

217 **Plastikkirurgi** | Plastic & reconstructive surgery | Plastische & Wiederherstellungschirurgie | Chirurgia plastica & ricostruttiva | Cirugía plástica & reconstructiva | 形成外科

219 **Ortopedi** | Orthopaedic surgery | Orthopädie | Chirurgia ortopedica | Cirugía ortopédica | 整形外科

# Sök och finn | Search and find

Katalogen är sökbar på två kirurgiska discipliner – plastikkirurgi och ortopedi. Längst bak i katalogen finns ett artikelnummerregister och ett produktnamnregister på svenska och engelska. Det finns även ett register för produkter inom de prioriterade områdena plastikkirurgi och ortopedi. Här nedan visas några förklaringar till produktgrupperna.

The catalogue is searchable from two surgical disciplines – plastic surgery and orthopaedics. The back of the catalogue contains an item number directory and product name registers in Swedish and English. There is also a register for product listings in the priority areas of plastic surgery and orthopaedics. Below you will find some descriptions of the product groups.

**1 PRODUKTBILD**  
Visas i ca 65% av den normala storleken.

**PRODUCT IMAGE**  
Is shown in approximate 65% of normal size.

**2 PROFIL**  
Visas i 90-100% av den normala storleken.

**PROFILE**  
Is shown in approximate 90-100% of normal size.

**1** Jabaley STILLE SuperCut XE dissektions sax |  
Jabaley STILLE SuperCut XE Dissecting Scissors

SuperCut XE scissors for dissection of tough tissue in hand surgery. Beveled blades.

**2**

101-8060-1	Straight	12.5 cm 5"	•	•	•
101-8062-1	Curved	12.5 cm 5"	•	•	•

Plastic Orthopaedic Popular Model

**3 4 5**

**5 POPULÄR MODELL**  
Instrument märkta med "Popular model" är våra mest populära instrument som ofta kan skickas direkt vid beställning. Tillfällig slutförsäljning kan dock uppstå och leverans sker då så snart nästa parti är färdigt. Vi strävar alltid efter kortast möjliga leveranstid.

**POPULAR MODEL**  
Instruments marked as "Popular model" are the most sold STILLE instruments. They are often available for immediate delivery. In some cases stock may be temporarily sold out and delivery will occur as soon as the next production batch is ready. We always try to make the time from order to delivery the shortest possible.

**3 PLASTIKKIRURGI**  
Lätta och gracila instrument för ingrepp med stora krav på precision.

**PLASTIC SURGERY**  
Lightweight and graceful instruments for procedures requiring high precision.

**4 ORTOPEDI**  
Lätta, gracila och hållbara instrument lämpliga för ortopedi.

**ORTHOPAEDIC**  
Lightweight, graceful and durable instruments suitable for orthopaedics.

# Historien

När Sverige med Serafimerlasarettet fick sitt första undervisningssjukhus 1752 tog den medicinska vården ett stort steg framåt. Men hundra år senare fanns det fortfarande inte fler än 200 kirurger i hela landet. Med inrättandet av Karolinska institutet 1810 förenades de två grenarna medicin och kirurgi och studenter utbildades nu i både invärtes och utvärtes sjukdomar. Dessutom anställde Karolinska institutet en instrumentmakare som utöver tillverkning även gav utbildning i instrumentvård.

Det var den verksamheten på Karolinska institutet som Albert Stille tog över 1841 när han startade sitt företag. Redan från början förde han en intensiv dialog med läkare och kirurger. Ofta vände de sig direkt till honom och hans medarbetare med förslag och instrumentmakarna var alltid lika ivriga att förverkliga deras idéer. Den här nära relationen mellan ett medicekniskt företag och olika medicinska institutioner var avgörande för den snabba utvecklingen inom medicin och kirurgi under 1800-talet.

De nyvunna kunskaperna inom mikrobiologi ledde till att man började sterilisera instrument, vilket minskade smittorisken för såväl patienter som kirurger och operationsassistenter. Och med viktiga upptäckter inom anestesi och antiseptisk sårbehandling vågade sig kirurgerna på allt djärvare ingrepp. Med hjälp av förfinade instrument skaffade de sig snabbt nya viktiga erfarenheter.

STILLE var först i världen med den tvådelade bentången redan 1872. Även andra produkter som revbenstången och gipssaxen gick hela tiden hand i hand med den snabba utvecklingen. Den nickelpläterade förlossningsstången kom 1877. Ytan stod emot påverkan från blod och var lättare att rengöra. Förnicklade instrument blev därefter standard på marknaden tills STILLE 1923 introducerade världens första instrument i rostfritt stål. Och med SuperCut 1982 skapades en unik kvalitetssax som fortfarande söker sin like i världen.

Albert Stille valdes 1868 in som ledamot av Svenska läkaresällskapet. *"För hans förtjänster om den kirurgiska och obstetriska instrumenttillverkningen i vårt land och de flera lyckliga dels egna uppfinningar, dels förbättringar av förutvarande modeller"*. Så löd rekommendationen från professorer och kirurger vid Serafimerlasarettet och Karolinska institutet. Nio år senare valdes även sonen Max in som ledamot.

Albert och Max Stille delade en äkta, livslång passion för att utveckla kvalitetsinstrument. Mer än 170 år senare lever deras fasta övertygelse, starka framåtanda och förtroagna samarbete med läkare och kirurger fortfarande kvar hos STILLE.



Karolinska institutet och Serafimerlasarettet på 1860-talet.  
Karolinska Institute and Serafimer Hospital in the 1860's.



# History

When the Serafimer Hospital in Stockholm became Sweden's first teaching hospital in 1752, medical care in the country took a great step forward. But one hundred years later there were still no more than 200 practicing surgeons in the country. With the establishment of the Karolinska Institute in 1810, the two branches, medicine and surgery, were united and students were educated in both internal and external diseases. In addition, the Karolinska Institute commissioned an instrument maker that went beyond manufacturing but also provided training regarding instrument care.

It was this business at the Karolinska Institute that Albert Stille took over in 1841 when he started his company. From the outset, he maintained an intensive dialogue with physicians and surgeons. Often, they turned directly to him and his colleagues with suggestions, and the instrument makers were always eager to realize their ideas. This close relationship between a medical device company and various medical institutions was crucial to the rapid developments that occurred in medicine and surgery in the 1800's.

The newly gained knowledge in microbiology led to sterilization of instruments, which reduced the risk of infection for patients, surgeons and surgical assistants. And with important discoveries in anesthetics and antiseptic wound treatment, surgeons dared to undertake increasingly bold surgical procedures. With the help of sophisticated new instruments, surgeons rapidly acquired important new experience.

STILLE was the first in the world with the double-action bone ronguer as early as 1872. Other instruments like rib forceps and plaster scissors also contributed to the rapid development. The nickel-plated obstetrical forceps came in 1877. The surface was blood resistant and was easier to clean. Nickel-plated instruments became the market standard until 1923 when STILLE introduced the world's first stainless steel instruments. And

with the SuperCut in 1982, STILLE created a unique quality scissors that are still unmatched in the world.

In 1868 Albert Stille was elected as a member of the Swedish Society of Medicine. *"For his merits in the area of surgical and obstetrical instrument manufacturing in our country, and the success of their own inventions, and improvements to previous designs."* Those were the words at his induction from professors and surgeons at the Serafimer Hospital and the Karolinska Institute. Nine years later, his son Max was also voted in as a member.

Albert and Max Stille shared a genuine, lifelong passion for developing quality instruments. More than 170 years later, their firm convictions, strong ambitions and earnest collaboration with physicians and surgeons still live on with STILLE.

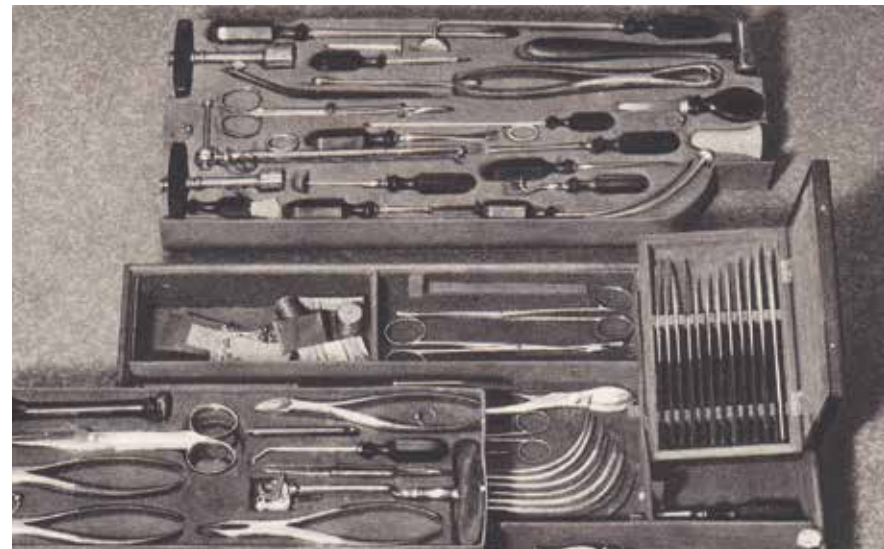

*Instrument för arméns sjukvård 1864.*

*Instruments for the Army Medical Corps 1864.*

# Hantverk och service

Järnsmede med manufaktur av knivar, saxar, tänger och hammare har länge varit hjärtat i Eskilstunas industrihistoriska arv. STILLE är det enda medicintekniska företag i världen som fortfarande tillverkar instrument från rundstål i egen smedja. Än idag kan man höra hur hejarhammare slår ut det uppvärmda stålämnet, rikthammarnas lätta slag mot skänklar och käftar och filarnas torra raspande mot det ohärdade stålet.

För instrumentmakarna har tillverkningen alltid behållit sin hantverksmässiga karaktär. Här förlitar man sig inte enbart på ritningar utan precis lika mycket på den egna känslan för funktion och egenskaper. Ett färdigt instrument fungerar som modell. Måtten sitter redan i nävarna. Instrumentmakarna känner den exakta böjningen med fingrarna och vet hur ett perfekt instrumentet känns i handen. Minsta defekt märks direkt.

Den där speciella fingertoppskänslan för funktion och egenskaper delar instrumentmakaren med kirurgen. Genom åren har STILLE samarbetat med en lång rad välkända kirurger över hela världen. De har på olika sätt

medverkat vid konstruktion och vidareutveckling. Deras erfarenhet och uppfinningsrikedom har ytterligare förfinat instrumenten. Därför kan en lång rad välkända kirurgers namn läggas till STILLES eget i sortimentet.

Instrumentmakarens sista arbetsmoment är att sätta firmamärket på det färdiga instrumentet. Under mer än 170 år har det kommit att stå för ett gediget hantverk, suverän funktion och överlägsen kvalitet. Det har gjort STILLE till ett osvikligt kännetecken för de unika instrumentegenskaper som kirurger världen över efterfrågar.

Alla instrument som regelbundet servas av STILLES skickliga instrumentmakare omfattas av en exklusiv 30-årsgaranti. Under servicen plockas instrumenten isär och rengörs in i minsta detalj, rörliga delar justeras och smörjs, saxblad slipas, eggar vässas, ytor renoveras och putsas innan instrumenten till slut funktionstestas. Den här noggranna omsorgen förlänger instrumentets livslängd och ökar patientsäkerheten.



# Craftsmanship and Service

Iron working and the manufacture of knives, scissors, pliers and hammers have long been at the heart of the city of Eskilstuna's industrial heritage. STILLE is the only medical instrument maker in the world that still manufactures instruments from tubular steel in their own forge. Even today, one can hear the beat as the drop hammer flattens the heated steel slabs, the light blow of chasing hammers to the shanks and jaws, and the dry rasping of files against the unhardened steel.

For makers of precision surgical instruments, production has always maintained its artisanal character. They rely not only on drawings but, just as much, on their own sense of functionality and feature. A complete instrument works like a model. The dimensions are already in the hands. Instrument makers know the precise bend with their own fingers, and they know how a perfect instrument should feel in the human hand. Minimum defects are immediately evident.

Instrument makers share that special fingertip sense of functionality with the surgeon. Through the years, STILLE has collaborated with a long list of renowned surgeons the world over. They have contributed in various ways to the construction and further development. Their experience and ingenuity has helped to further refine surgical instruments. Therefore, many wellknown surgeons' names have been added to STILLE's wide range of instruments.

An instrument maker's final task is to put the company name on the finished instrument. For more than 170 years, it has come to stand for solid craftsmanship, superb performance and superior quality. This has made the STILLE name synonymous with the unique features and performance that surgeon's around the world demand.

All instruments that are regularly serviced by STILLE's skilled technicians are covered by an exclusive 30-year warranty. During the service process the instruments are disassembled and cleaned thoroughly, moving parts are adjusted and lubricated, scissor blades are sharpened, edges are honed, surfaces refinished and cleaned before the instruments undergo comprehensive testing. This meticulous maintenance prolongs the life of the instrument and increases patient safety.



**“SCISSORS, PLEASE!”** Kirurgen över hela världen föredrar STILLES saxar. De är lätta och välbalanserade med en jämn, mjuk känsla som följer minsta rörelse så att saxen blir en naturlig förlängning av handen. Saxens utformning ger ett fast grepp med maximal klippförmåga för alla typer av mjuk vävnad. Oavsett modell är precisionen perfekt, hela vägen ut i spetsarna.

Sedan STILLE uppfann den första SuperCut-saxen redan 1982 har många försökt sig på att kopiera den. Men efter tre decennier kan fortfarande inget annat fabrikanter mäta sig med denna handtillverkade supersax. En av de främsta egenskaperna är de specialdesignade skärytorna. Med ett saxslipat och ett knivslipat blad skär sig saxen mjukt och effektivt genom vävnaden. Snittet blir perfekt. Varje gång.

Saxsortimentet har utökats med ergonomiska saxar med vinklade skänklor för ett bekvämare grepp. Precis som alla andra saxar från STILLE är de högglanspolerade och kan vid service tas isär för enklare rengöring och sterilisering. Det ökar säkerheten för patient och kirurg samt förlänger instrumentets livstid. All service sköts av våra egna skickliga instrumentmakare. En sax från STILLE behåller sin höga kvalitet år efter år.



**“SCISSORS, PLEASE!”** Surgeons worldwide prefer scissors from STILLE. They are light and well-balanced with a smooth, soft feel that follows every movement so that the scissors become a natural extension of the hand. The scissor's design provides a firm grip with maximum cutting power for all types of soft tissue. Regardless of the model they are perfectly precise - all the way to the tip.

Since STILLE invented the first SuperCut-scissors back in 1982, many have attempted to imitate the design. But after three decades no other brand can measure up to the handmade craftsmanship of the SuperCut. One of the main features is the specially designed cutting surfaces. With one scissor blade and one knife blade the scissors cut smoothly and efficiently through soft tissue. A perfect cut. Every time!

The product line has been expanded to include ergonomic scissors that feature angled handles for a more comfortable grip. Like all scissors from STILLE they are highly polished and can be disassembled for easy maintenance, cleaning and sterilization. This increases safety for the patient and the surgeon and extends the instrument's effective lifetime. All service is handled by our own skilled craftsmen. A pair of scissors from STILLE retains their high quality year after year.

# Saxar | Scissors | Scheren | Forbici | Tijeras | 剪刀 (はさみ)

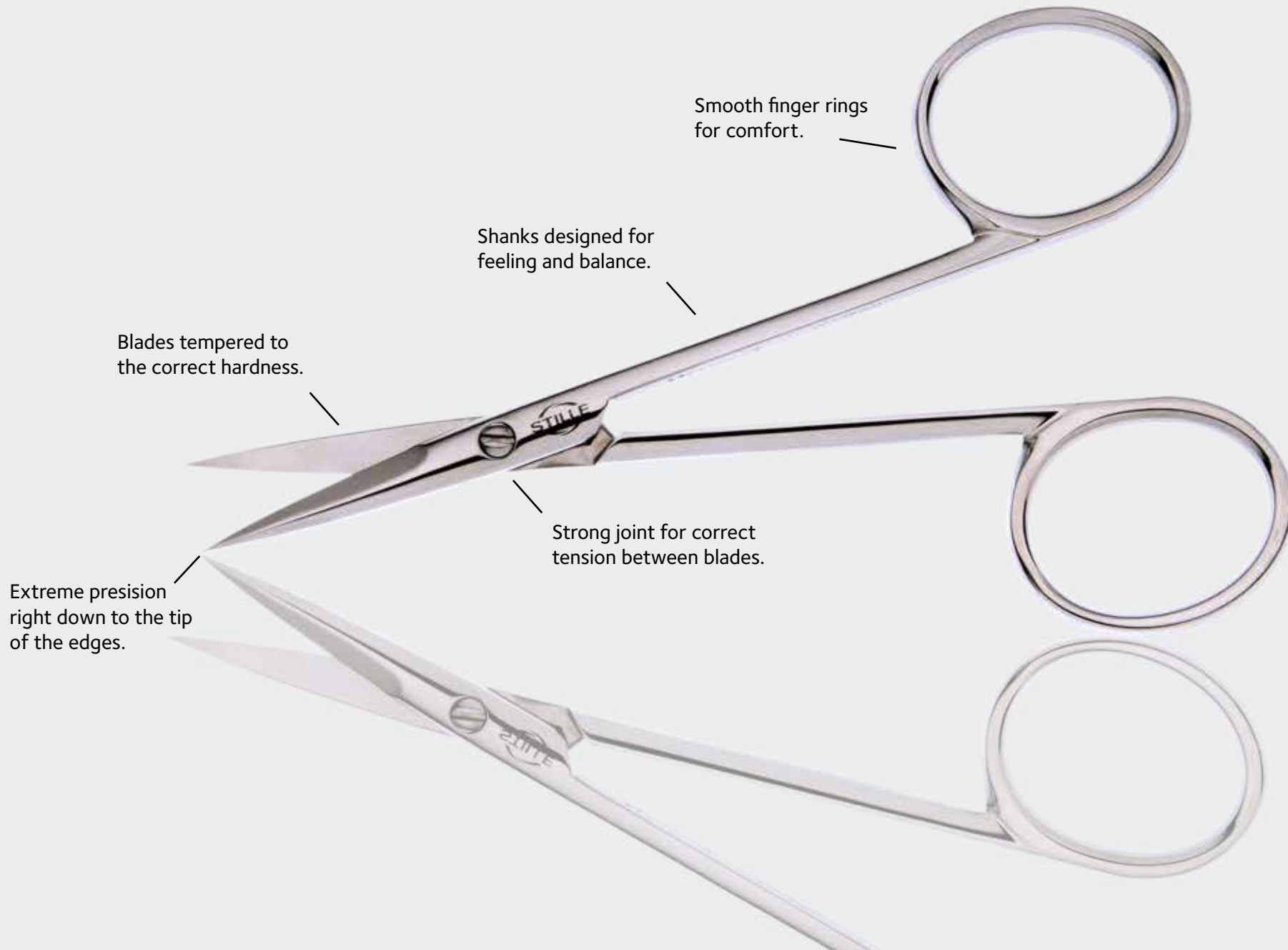

Smooth finger rings  
for comfort.

Shanks designed for  
feeling and balance.

Blades tempered to  
the correct hardness.

Strong joint for correct  
tension between blades.

Extreme precision  
right down to the tip  
of the edges.



STILLE Ögonsax | STILLE Eye Scissors

### ORIGINAL

Saxar har alltid tillhört STILLES storsäljare alltsedan de började tillverkas på 1800-talet. Genom åren har de ständigt förbättrats och fler specialmodeller har tillkommit. Idag finns de i totalt ca 200 varianter i alla storlekar och utformningar.

Originalsaxarna tillverkas i rostfritt stål av högsta kvalitet med höglanspolerad yta. De är välbalanserade med god skärstyrka ända ut i spetsarna och ligger bra i handen. Det finns originalsaxar för alla typer av mjukvävnad och de kan även användas för att klippa gasbinda, tråd och suturer.

### SUPERCUT

Saxarnas sax uppfanns 1982. Många kirurger anser att SuperCut är världens absolut bästa kirurgisax. Den passar alla typer av mjuk vävnad och precisionen och prestandan är välkänd bland kirurger över hela världen.

Det revolutionerande med SuperCut är skärytorna som samarbetar på ett unikt sätt. Det ena bladet är saxslipat och det andra är knivslipat så att saxen skär sig fram genom vävnaden. Det ger maximal skärstyrka med minimal kraft och ett perfekt snitt. Slipningen gör saxen lämplig för både höger- och vänsterhänta. Trots många år på marknaden har ingen lyckats skapa en kopia som kan överträffa originalet.

### ORIGINAL

Scissors have always been STILLE's bestseller ever since they were first produced in the 1800's. Through the years they have been continually improved and more special models have been introduced. Currently, there are in total about 200 different varieties in all sizes and shapes.

Our original scissors are manufactured of the highest quality, polished stainless steel. They are well balanced with outstanding cutting power right down to the tips and they fit well in the surgeon's hand. There are original scissors for all types of soft tissue and they can also be used to cut gauze, wire and sutures.

### SUPERCUT

These unique scissors were introduced in 1982. Many surgeons believe that the SuperCut are unsurpassed as the world's best surgical scissors. They are suitable for all types of soft tissue and the precision and performance are well known among surgeons worldwide.

The revolutionary SuperCut scissors feature cutting surfaces that work together in a unique way. One blade is a scissor blade and the other is a knife blade to enable the scissors to cut precisely through the soft tissue. They provide maximum cutting power with minimal force and produce a perfect cut. The sharpening makes the scissors suitable for both right and left handed users. Despite many years on the market, other brands have not been able to create an imitation that can surpass the original SuperCut scissors.



STILLE-Mayo SuperCut XE dissektionssax |  
STILLE-Mayo SuperCut XE Dissecting Scissors



Stevens-STILLE SuperCut XE ergonomisk tenotomisax | Stevens-STILLE SuperCut XE Ergonomic Tenotomy Scissors

### ERGONOMISKA SAXAR

En naturlig fortsättning på arbetet med att skapa perfekta saxar har varit att vidareutveckla deras ergonomiska egenskaper. Kirurgiska saxar hålls normalt i ett precisionsgrepp med tummen och lång- eller ringfingret. Vid mer tidskrävande ingrepp tröttnas handen ut snabbare.

Lösningen är att vinkla skänklarna så att handen kan arbeta närmare sitt normala viloläge. Med ett större mellanrum mellan fingeröglorna motverkas spänningar och trötthet och handen orkar arbeta längre. Samtliga ergonomiska saxar är av modellen SuperCut med sina unika egenskaper. Sax- och knivslipade blad samverkar för maximal skärstyrka med minimal kraft och exakt precision.

### ERGONOMIC SCISSORS

A natural extension of the ongoing effort to create the perfect scissors has been the further development of their ergonomic properties. Surgical scissors are normally held in a precise grip using the thumb and middle or ring finger. For more time-consuming procedures this can cause the hand to become fatigued faster.

The solution is to angle the shanks so that the hand can work closer to its normal resting position. With a larger gap between the finger loops, tension and fatigue is countered and the hand can work more comfortably for a longer period. All ergonomic scissors are SuperCut models with their unique characteristics. Scissor and knife sharpened blades work together for maximum cutting power with minimal effort and exact precision.

### STILLE ögonsax | STILLE Eye Scissors

Delicate eye scissors with sharp or blunt tips and large finger rings. These are also called iris scissors and are used for nerves, tendons and vessels. They are intended for facial surgery and any type of delicate surgery. Beveled blades.

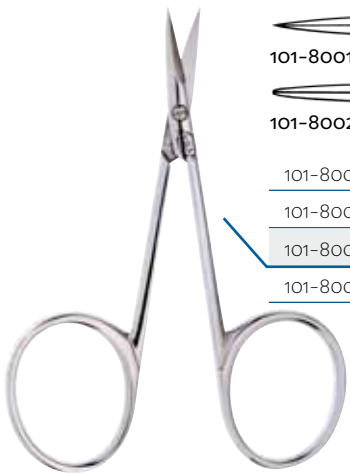

101-8001					
101-8002					
101-8001	Straight	Sharp	9.5 cm 3.75"	●	
101-8002	Straight	Blunt	9.5 cm 3.75"	●	
101-8003	Curved	Sharp	9.5 cm 3.75"	●	●
101-8004	Curved	Blunt	9.5 cm 3.75"	●	

Plastic  
 Orthopaedic  
 Popular Model

### STILLE ögonsax | STILLE Eye Scissors

Eye scissors for delicate work. Large finger rings for a comfortable grip. Beveled blades.

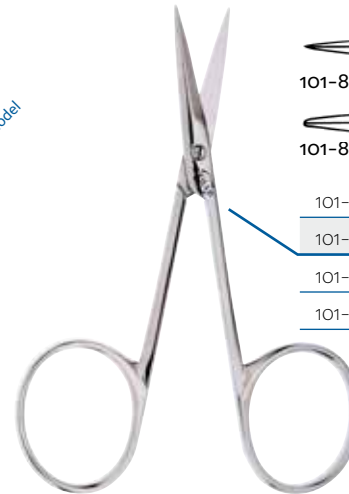

101-8010					
101-8011					
101-8010	Straight	Sharp	10 cm 4"	●	●
101-8011	Straight	Blunt	10 cm 4"	●	
101-8015	Curved	Sharp	10 cm 4"	●	●
101-8016	Curved	Blunt	10 cm 4"	●	●

Plastic  
 Orthopaedic  
 Popular Model

### STILLE SuperCut XE ögonsax | STILLE SuperCut XE Eye Scissors

SuperCut XE eye scissors with sharp or blunt tips and extremely sharp edges. Beveled blades.



101-8010-1					
101-8011-1					
101-8010-1	Straight	Sharp	10 cm 4"	●	●
101-8011-1	Straight	Blunt	10 cm 4"	●	
101-8015-1	Curved	Sharp	10 cm 4"	●	●
101-8016-1	Curved	Blunt	10 cm 4"	●	

Plastic  
 Orthopaedic  
 Popular Model



### STILLE SuperCut XE ögonlockssax | STILLE SuperCut XE Blepharoplasty Scissors

Short delicate SuperCut XE scissors suitable for blepharoplasty.

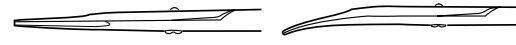

Model	Tip Shape	Length	Material
101-8018-1	Straight	9.5 cm 3.75"	Plastic
101-8019-1	Curved	9.5 cm 3.75"	Orthopaedic Popular Model



### STILLE SuperCut XE ergonomisk ögonlockssax | STILLE SuperCut XE Ergonomic Blepharoplasty Scissors

Blepharoplasty SuperCut XE scissors with ergonomically designed shanks for a more relaxed grip.

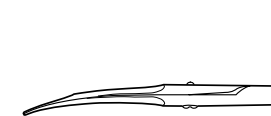

Model	Tip Shape	Length	Material
101-8019-2	Curved	9.5 cm 3.75"	Orthopaedic Popular Model

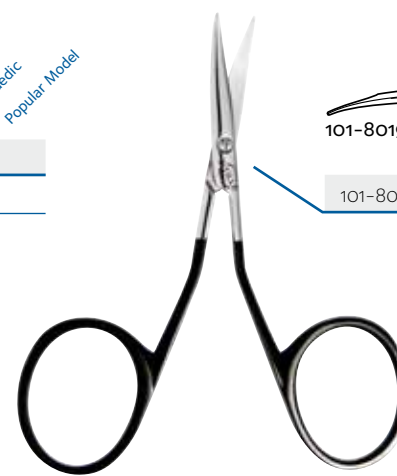

### Ragnell STILLE SuperCut XE ögonlockssax | Ragnell STILLE SuperCut XE Blepharoplasty Scissors

Short delicate SuperCut XE scissors with blunt, flat tips for blepharoplasty.

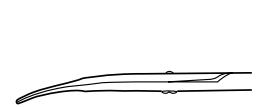

Model	Tip Shape	Length	Material
101-8031-1	Curved	9.5 cm 3.75"	Orthopaedic Popular Model

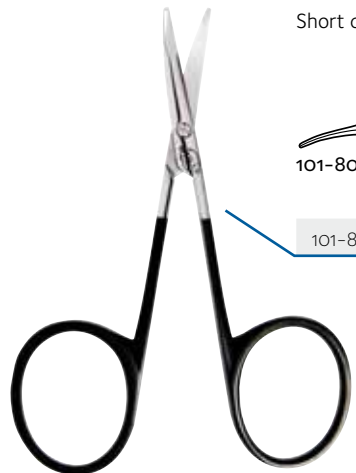

### Ragnell STILLE SuperCut XE ergonomisk ögonlockssax | Ragnell STILLE SuperCut XE Ergonomic Blepharoplasty Scissors

Blepharoplasty SuperCut XE scissors with ergonomically designed shanks for a more relaxed grip.



Model	Tip Shape	Length	Material
101-8031-2	Curved	9.5 cm 3.75"	Orthopaedic Popular Model



### Kaye STILLE dissektionssax | Kaye STILLE Dissecting Scissors

Scissors with serrated blades for "holding" the tissue, making it easier to cut exactly as far as intended.

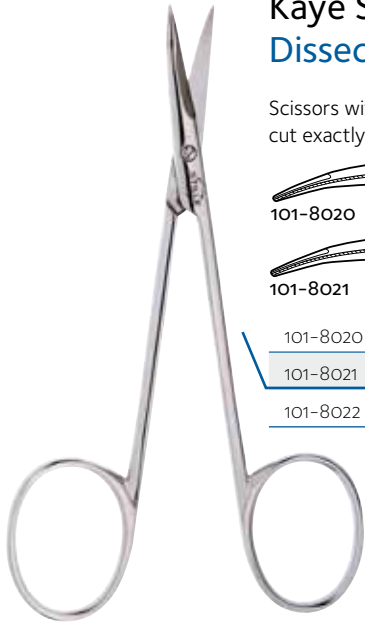

101-8020	101-8022						
101-8021							
101-8020	Blunt serrated	Curved	10 cm 4"	●	Plastic	Orthopaedic	Popular Model
101-8021	Blunt serrated	Curved	12.5 cm 5"	●			
101-8022	Sharp serrated	Curved	12.5 cm 5"	●			●

### Kaye STILLE SuperCut XE dissektionssax | Kaye STILLE SuperCut XE Dissecting Scissors

SuperCut XE version for improved cutting performance.

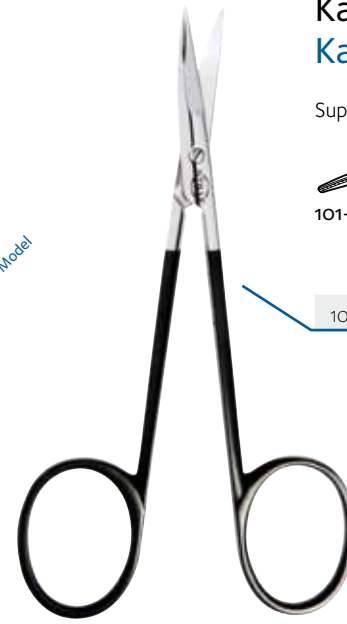

101-8021-1							
101-8021-1	Blunt serrated	Curved	12.5 cm 5"	●	Plastic	Orthopaedic	Popular Model

### Jabaley STILLE dissektionssax | Jabaley STILLE Dissecting Scissors

Sharp scissors suitable for hand surgery, where very strong scissors are used. Beveled blades.



101-8060	101-8062						
101-8060	Straight	12.5 cm 5"	●	●	Plastic	Orthopaedic	Popular Model
101-8062	Curved	12.5 cm 5"	●	●			●

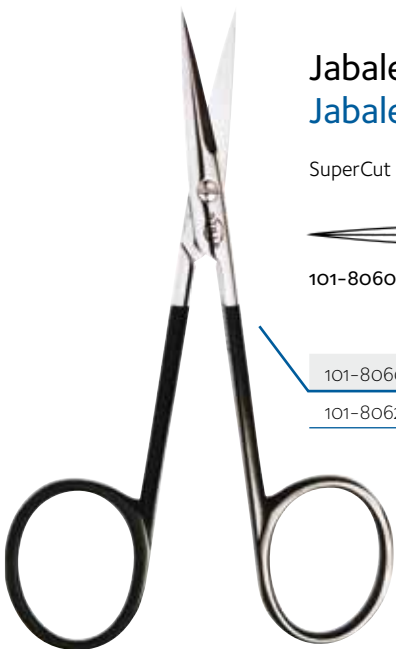

### Jabaley STILLE SuperCut XE dissektionssax | Jabaley STILLE SuperCut XE Dissecting Scissors

SuperCut XE scissors for dissection of tough tissue in hand surgery. Beveled blades.

101-8060-1		101-8062-1							
101-8060-1	Straight	12.5 cm 5"	<table border="1"> <tr> <td>Plastic</td> <td>Orthopaedic</td> <td>Popular Model</td> </tr> <tr> <td>●</td> <td>●</td> <td>●</td> </tr> </table>	Plastic	Orthopaedic	Popular Model	●	●	●
Plastic	Orthopaedic	Popular Model							
●	●	●							
101-8062-1	Curved	12.5 cm 5"	<table border="1"> <tr> <td>Plastic</td> <td>Orthopaedic</td> <td>Popular Model</td> </tr> <tr> <td>●</td> <td>●</td> <td>●</td> </tr> </table>	Plastic	Orthopaedic	Popular Model	●	●	●
Plastic	Orthopaedic	Popular Model							
●	●	●							

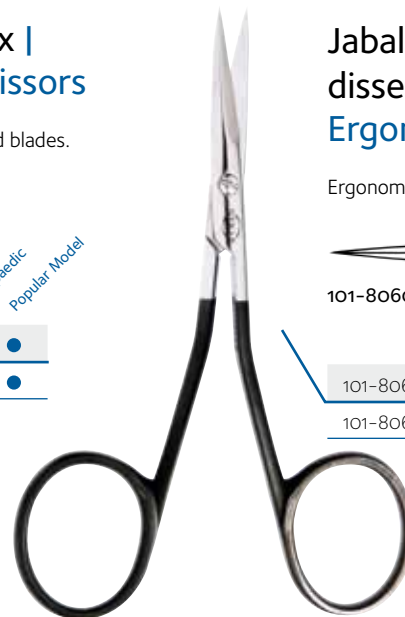

### Jabaley STILLE SuperCut XE ergonomisk dissektionssax | Jabaley STILLE SuperCut XE Ergonomic Dissecting Scissors

Ergonomic model to avoid fatigue in the hand. Beveled blades.

101-8060-2		101-8062-2							
101-8060-2	Straight	12.5 cm 5"	<table border="1"> <tr> <td>Plastic</td> <td>Orthopaedic</td> <td>Popular Model</td> </tr> <tr> <td>●</td> <td>●</td> <td></td> </tr> </table>	Plastic	Orthopaedic	Popular Model	●	●	
Plastic	Orthopaedic	Popular Model							
●	●								
101-8062-2	Curved	12.5 cm 5"	<table border="1"> <tr> <td>Plastic</td> <td>Orthopaedic</td> <td>Popular Model</td> </tr> <tr> <td>●</td> <td>●</td> <td></td> </tr> </table>	Plastic	Orthopaedic	Popular Model	●	●	
Plastic	Orthopaedic	Popular Model							
●	●								



### Mayo STILLE dissektionssax | Mayo STILLE Dissecting Scissors

The most used scissors, for all types of surgery. Used for routine dissection and cutting in tissue. Beveled blades.

101-8080-15		101-8082-15							
101-8080-17		101-8082-17							
101-8080-15	Straight	15 cm 6"	<table border="1"> <tr> <td>Plastic</td> <td>Orthopaedic</td> <td>Popular Model</td> </tr> <tr> <td>●</td> <td>●</td> <td>●</td> </tr> </table>	Plastic	Orthopaedic	Popular Model	●	●	●
Plastic	Orthopaedic	Popular Model							
●	●	●							
101-8080-17	Straight	17 cm 6.75"	<table border="1"> <tr> <td>Plastic</td> <td>Orthopaedic</td> <td>Popular Model</td> </tr> <tr> <td>●</td> <td>●</td> <td></td> </tr> </table>	Plastic	Orthopaedic	Popular Model	●	●	
Plastic	Orthopaedic	Popular Model							
●	●								
101-8082-15	Curved	15 cm 6"	<table border="1"> <tr> <td>Plastic</td> <td>Orthopaedic</td> <td>Popular Model</td> </tr> <tr> <td>●</td> <td>●</td> <td>●</td> </tr> </table>	Plastic	Orthopaedic	Popular Model	●	●	●
Plastic	Orthopaedic	Popular Model							
●	●	●							
101-8082-17	Curved	17 cm 6.75"	<table border="1"> <tr> <td>Plastic</td> <td>Orthopaedic</td> <td>Popular Model</td> </tr> <tr> <td>●</td> <td>●</td> <td>●</td> </tr> </table>	Plastic	Orthopaedic	Popular Model	●	●	●
Plastic	Orthopaedic	Popular Model							
●	●	●							

### Mayo STILLE SuperCut XE dissektionssax | Mayo STILLE SuperCut XE Dissecting Scissors

SuperCut XE dissecting scissors for tough tissue. Beveled blades.

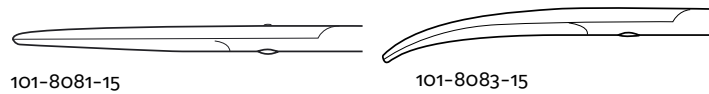

101-8081-15

101-8083-15

			Plastic	Orthopaedic	Popular Model
101-8081-15	Straight	15 cm 6"	●	●	
101-8083-15	Curved	15 cm 6"	●	●	



### STILLE-Mayo dissektionssax | STILLE-Mayo Dissecting Scissors

Sturdy dissecting scissors with rounded blades.

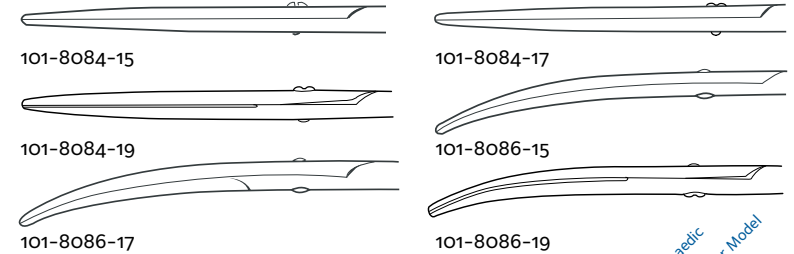

101-8084-15

101-8084-17

101-8084-19

101-8086-15

101-8086-17

101-8086-19

				Plastic	Orthopaedic	Popular Model
101-8084-15	Rounded blades	Straight	15 cm 6"	●	●	●
101-8084-17	Rounded blades	Straight	17 cm 6.75"	●	●	●
101-8084-19	Rounded blades	Straight	19 cm 7.5"	●	●	
101-8086-15	Rounded blades	Curved	15 cm 6"	●	●	●
101-8086-17	Rounded blades	Curved	17 cm 6.75"	●	●	●
101-8086-19	Rounded blades	Curved	19 cm 7.5"	●	●	



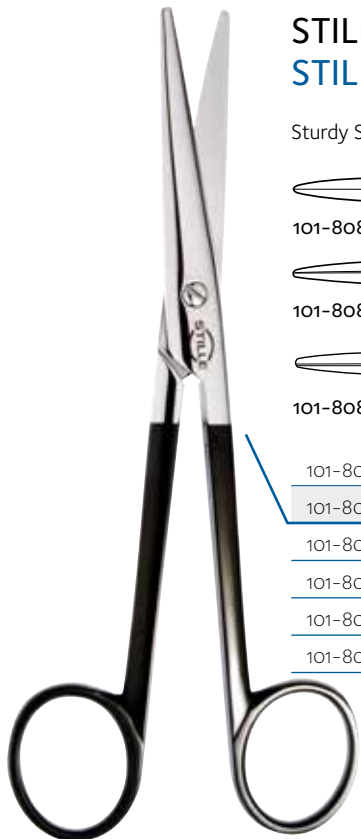

### STILLE-Mayo SuperCut XE dissektionssax | STILLE-Mayo SuperCut XE Dissecting Scissors

Sturdy Super Cut scissors with rounded blades for dissection of tough tissue.

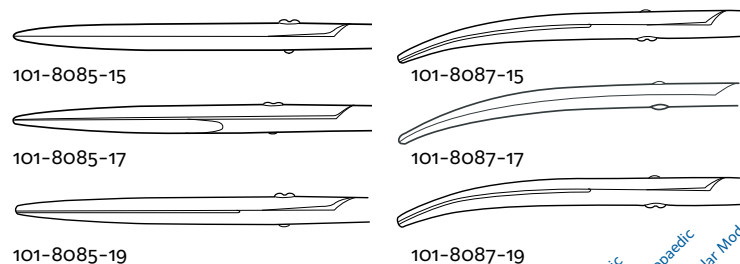

Model	Blade Shape	Handle Shape	Length	Plastic	Orthopaedic	Popular Model
101-8085-15	Rounded blades	Straight	15 cm 6"	●	●	
101-8085-17	Rounded blades	Straight	17 cm 6.75"	●	●	●
101-8085-19	Rounded blades	Straight	19 cm 7.5"	●	●	
101-8087-15	Rounded blades	Curved	15 cm 6"	●	●	●
101-8087-17	Rounded blades	Curved	17 cm 6.75"	●	●	●
101-8087-19	Rounded blades	Curved	19 cm 7.5"	●	●	●

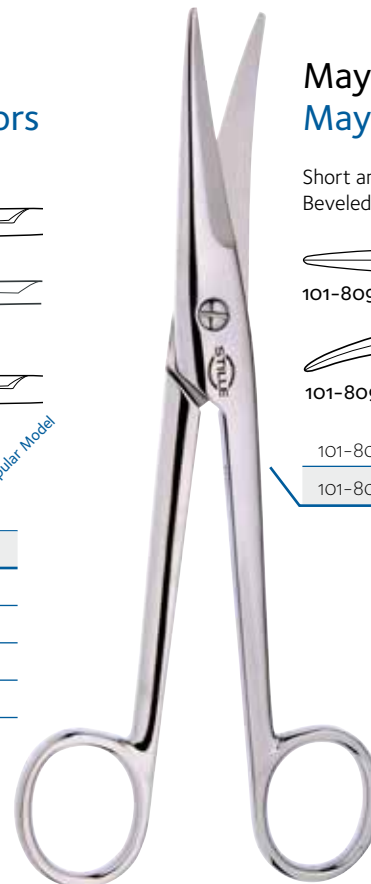

### Mayo-Noble STILLE dissektionssax | Mayo-Noble STILLE Dissecting Scissors

Short and strong dissecting scissors mainly for orthopaedic surgeons. Beveled blades.

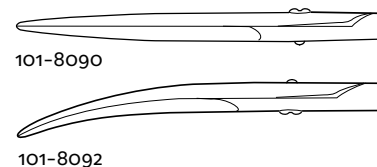

Model	Blade Shape	Length	Plastic	Orthopaedic	Popular Model
101-8090	Straight	18 cm 7"		●	
101-8092	Curved	18 cm 7"		●	

### Baby Mayo STILLE dissektionssax | Baby Mayo STILLE Dissecting Scissors

Delicate version of the regular Mayo scissors. Mainly for plastic- and hand surgery. Beveled blades.



Model	Blade Shape	Length	Plastic	Orthopaedic	Popular Model
101-8100-15	Straight	15 cm 6"	●	●	
101-8102-15	Curved	15 cm 6"	●	●	●



### Sims STILLE dissektionssax | Sims STILLE Dissecting Scissors

Mainly used in gynecological and other pelvic surgery. Beveled blades.



101-8138

Plastic  
Orthopaedic  
Popular Model

101-8138	Curved	20 cm 8"
----------	--------	----------



### Baby Metzenbaum STILLE dissektionssax | Baby Metzenbaum STILLE Dissecting Scissors

Short, delicate dissection scissors with rounded blades. Used in delicate surgery requiring small instruments.



101-8160



101-8162

Plastic  
Orthopaedic  
Popular Model

101-8160	Straight	12.5 cm 5"	●	●
101-8162	Curved	12.5 cm 5"	●	● ●

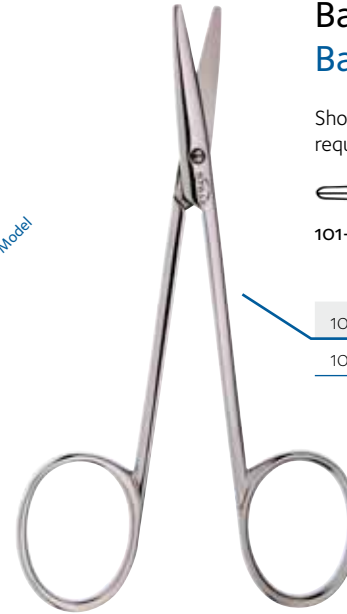

### Baby Metzenbaum STILLE SuperCut XE dissektionssax | Baby Metzenbaum STILLE SuperCut XE Dissecting Scissors

Super Cut dissection scissors for tough tissue. Used in delicate surgery requiring small instruments.



101-8161



101-8163

Plastic  
Orthopaedic  
Popular Model

101-8161	Straight	12.5 cm 5"	●	●
101-8163	Curved	12.5 cm 5"	●	● ●





**Baby Metzenbaum STILLE SuperCut XE ergonomisk dissektionssax | Baby Metzenbaum STILLE SuperCut XE Ergonomic Dissecting Scissors**

Ergonomic model for better control. Rounded blades.



101-8163-2

101-8163-2	Curved	12.5 cm 5"	●	●
------------	--------	------------	---	---

Plastic  
Orthopaedic  
Popular Model

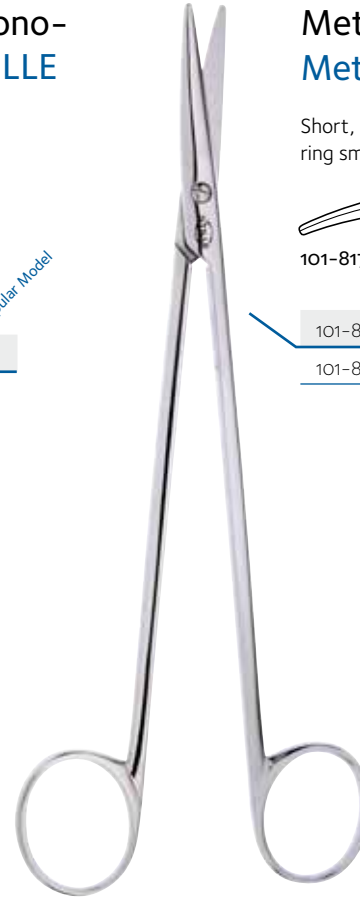

**Metzenbaum STILLE gracil dissektionssax | Metzenbaum STILLE Delicate Dissecting Scissors**

Short, delicate dissection scissors with rounded blades. Used in delicate surgery requiring small instruments.



101-8172

101-8172-18	Curved delicate	18 cm 7"	●	●	●
101-8172-23	Curved delicate	23 cm 9"	●	●	●

Plastic  
Orthopaedic  
Popular Model

**Metzenbaum STILLE gracil SuperCut XE dissektionssax | Metzenbaum STILLE Delicate SuperCut XE Dissecting Scissors**

Very delicate version with Super Cut edges and fine rounded tips.

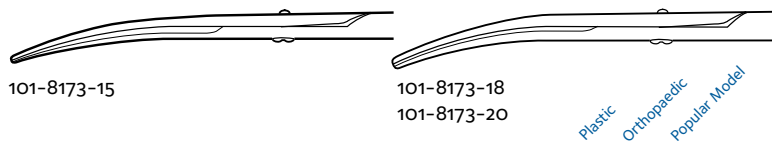

101-8173-15

101-8173-18  
101-8173-20

Plastic  
Orthopaedic  
Popular Model

101-8173-15	Curved delicate	15 cm 6"	●	●	●
101-8173-18	Curved delicate	18 cm 7"	●	●	●
101-8173-20	Curved delicate	20 cm 8"	●	●	●



**Metzenbaum STILLE dissektionssax | Metzenbaum STILLE Dissecting Scissors**

Dissecting scissors with rounded blades and tips. Used in all specialties for fine dissection. Metzenbaum is one of STILLE's most popular scissors model and is available in a variety of shapes and sizes.

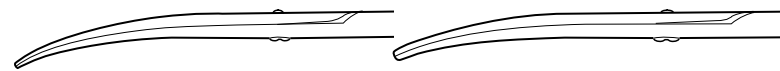

101-8174-15, 101-8174-18  
101-8174-20, 101-8174-23

101-8174-26

Plastic  
Orthopaedic  
Popular Model

101-8174-15	Curved	15 cm 6"	●	●	●
101-8174-18	Curved	18 cm 7"	●	●	●
101-8174-20	Curved	20 cm 8"	●	●	●
101-8174-23	Curved	23 cm 9"	●	●	●
101-8174-26	Curved	26 cm 10.25"	●	●	●





### Metzenbaum STILLE SuperCut XE dissektionssax | Metzenbaum STILLE SuperCut XE Dissecting Scissors

The popular Metzenbaum dissecting scissors with Super Cut edges. Rounded/beveled blades.

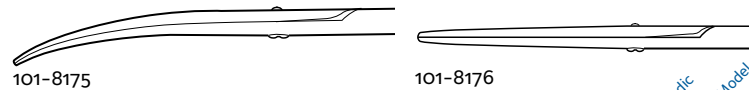

			Plastic	Orthopaedic	Popular Model
101-8175-15	Curved	15 cm 6"	●	●	●
101-8175-18	Curved	18 cm 7"	●	●	●
101-8175-20	Curved	20 cm 8"	●	●	●
101-8175-23	Curved	23 cm 9"	●	●	●
101-8175-26	Curved	26 cm 10.25"	●	●	●
101-8175-30	Curved	30 cm 12"		●	
101-8175-33	Curved	33 cm 13"		●	
101-8176-15	Straight	15 cm 6"	●	●	
101-8176-18	Straight	18 cm 7"	●	●	
101-8176-20	Straight	20 cm 8"	●	●	
101-8176-23	Straight	23 cm 9"	●	●	
101-8176-26	Straight	26 cm 10.25"	●	●	

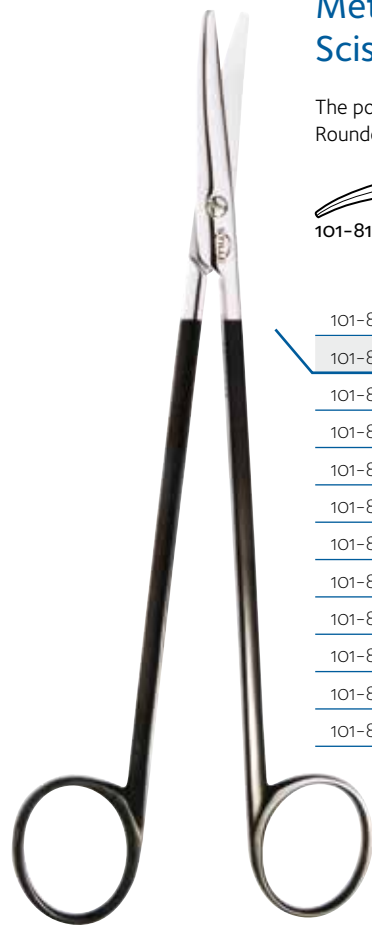

### Metzenbaum STILLE SuperCut XE ergonomisk dissektionssax | Metzenbaum STILLE SuperCut XE Ergonomic Dissecting Scissors

Metzenbaum Super Cut scissors with ergonomically designed shanks for a more comfortable grip. Rounded/beveled blades.

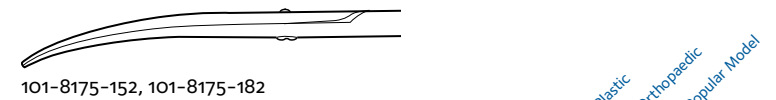

			Plastic	Orthopaedic	Popular Model
101-8175-152	Curved	15 cm 6"	●	●	
101-8175-182	Curved	18 cm 7"	●	●	



### Ragnell STILLE dissektionssax | Ragnell STILLE Dissecting Scissors

Dissecting scissors with flat, rounded tips. Often used in plastic surgery. Is also called Killner by some manufacturers. The short models are used for undermining in plastic surgery and the long models are used for further dissection.

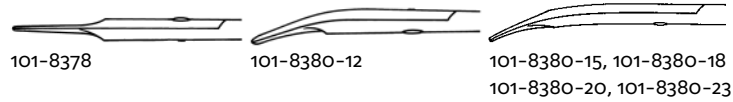

			Plastic	Orthopaedic	Popular Model
101-8378	Straight	12.5 cm 5"	●	●	
101-8380-12	Curved	12.5 cm 5"	●	●	●
101-8380-15	Curved	15 cm 6"	●	●	
101-8380-18	Curved	18 cm 7"	●	●	●
101-8380-20	Curved	20 cm 8"	●	●	●
101-8380-23	Curved	23 cm 9"	●	●	



### Ragnell STILLE SuperCut XE dissektionssax | Ragnell STILLE SuperCut XE Dissecting Scissors

Super Cut version of the Ragnell scissors. For precise undermining of flaps.

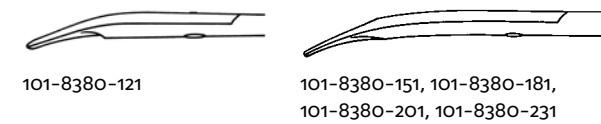

			Plastic	Orthopaedic	Popular Model
101-8380-121	Curved	12.5 cm 5"	●	●	●
101-8380-151	Curved	15 cm 6"	●	●	
101-8380-181	Curved	18 cm 7"	●	●	●
101-8380-201	Curved	20 cm 8"	●	●	●
101-8380-231	Curved	23 cm 9"	●	●	



### Ragnell STILLE SuperCut XE ergonomisk dissektionssax | Ragnell STILLE SuperCut XE Ergonomic Dissecting Scissors

Ergo Super Cut versions of Ragnell scissors for precise undermining of flaps and comfortable grip.

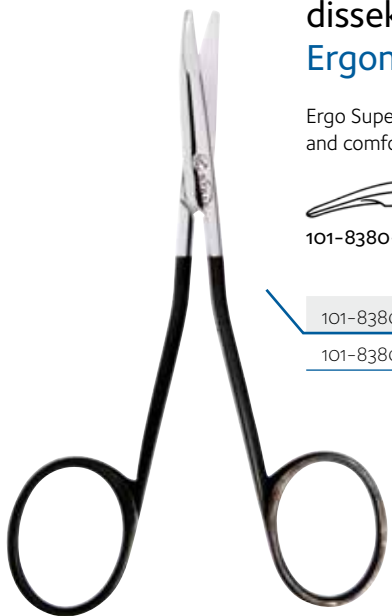

101-8380-122		101-8380-152		Plastic	Orthopaedic	Popular Model
101-8380-122	Curved	12,5 cm 5"		●	●	
101-8380-152	Curved	15 cm 6"		●	●	

### Thorek STILLE dissektionssax | Thorek STILLE Dissecting Scissors

Strongly curved dissecting scissors for good visibility. Rounded blades.

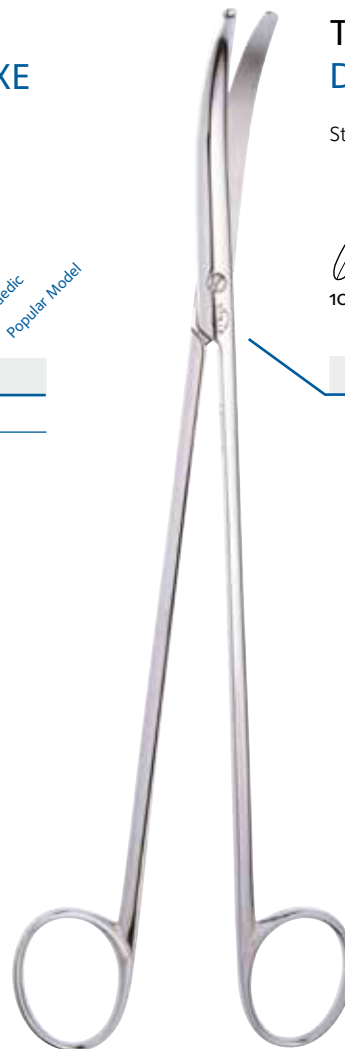

101-8470				Plastic	Orthopaedic	Popular Model
101-8470	Strongly curved	21 cm 8.25"				

### STILLE Cooper operations sax | STILLE Cooper Operating Scissors

General purpose utility scissors, often used for sutures, gauze etc. Beveled blades.

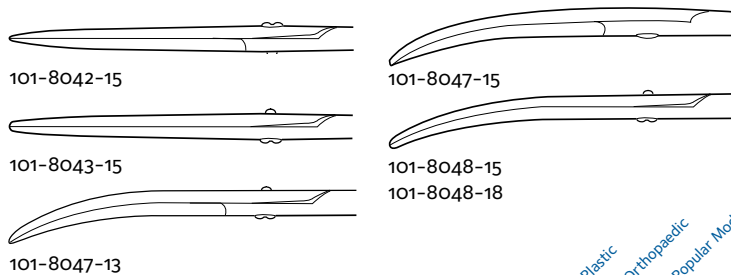

				Plastic	Orthopaedic	Popular Model
101-8042-15	Sharp/blunt	Straight	15 cm 6"	●	●	
101-8043-15	Blunt/blunt	Straight	15 cm 6"	●	●	
101-8047-13	Sharp/blunt	Curved	13.5 cm 5.25"	●	●	
101-8047-15	Sharp/blunt	Curved	15 cm 6"	●	●	
101-8048-15	Blunt/blunt	Curved	15 cm 6"	●	●	
101-8048-18	Blunt/blunt	Curved	18 cm 7"	●	●	



### Mayo-Harrington STILLE operations sax | Mayo-Harrington STILLE Operating Scissors

Very useful operating scissors for deep surgery like gynecology and thoracic surgery. Beveled blades.

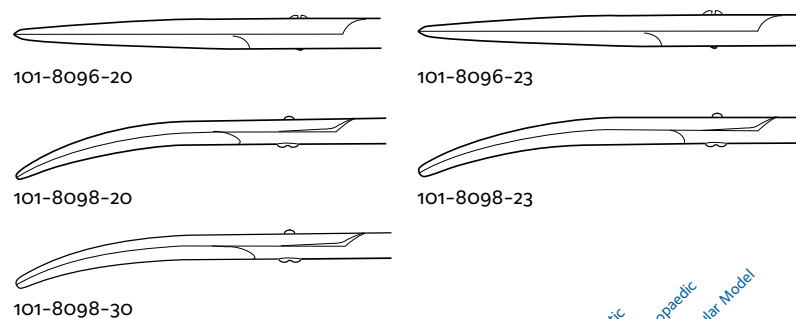

				Plastic	Orthopaedic	Popular Model
101-8096-20	Straight	20 cm 8"		●		
101-8096-23	Straight	23 cm 9"		●		
101-8098-20	Curved	20 cm 8"		●	●	
101-8098-23	Curved	23 cm 9"		●	●	
101-8098-30	Curved	30 cm 12"		●		

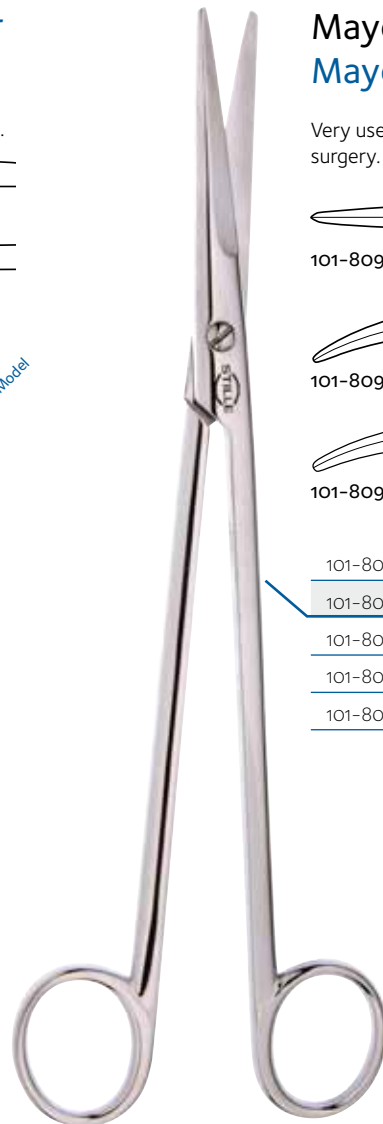

### Mayo-Harrington STILLE SuperCut XE operations sax | Mayo-Harrington STILLE SuperCut XE Operating Scissors

Operating Super Cut scissors useful for several surgical disciplines.  
Beveled blades.

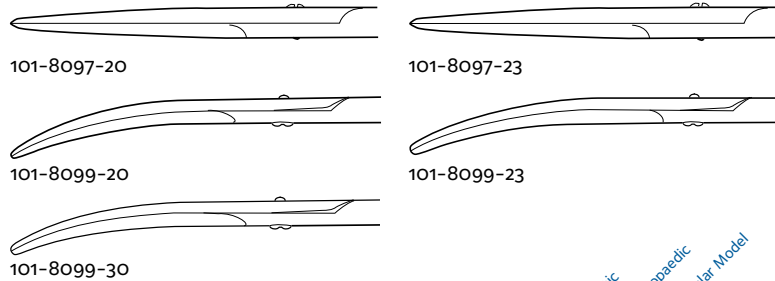

101-8097-20

101-8097-23

101-8099-20

101-8099-23

101-8099-30

101-8097-20	Straight	20 cm 8"	●
101-8097-23	Straight	23 cm 9"	●
101-8099-20	Curved	20 cm 8"	●
101-8099-23	Curved	23 cm 9"	● ●
101-8099-30	Curved	30 cm 12"	●

Plastic  
Orthopaedic  
Popular Model

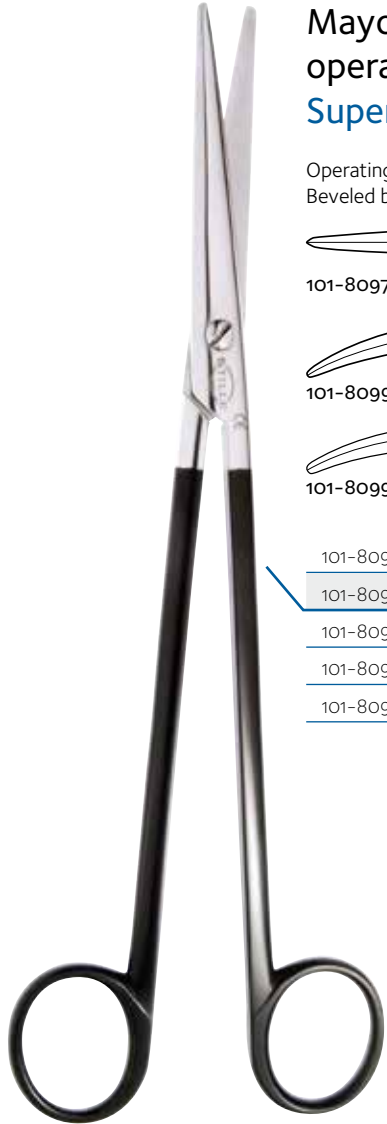

### Boyd-STILLE tonsillsax | Boyd-STILLE Tonsil Scissors

Scissors with sharp tips and S-shaped shanks for greater visibility. Rounded blades.



101-8420

101-8420 Curved S-shaped shanks 17 cm 6.75"

Plastic  
Orthopaedic  
Popular Model

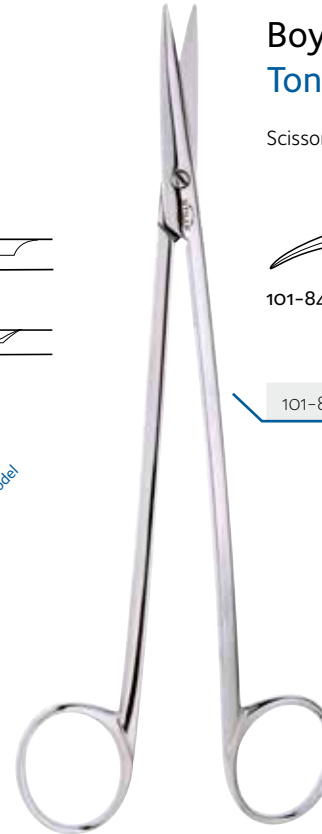

### Ragnell STILLE operations sax | Ragnell STILLE Operating Scissors

Mammary plastic scissors intended for breast surgery. Rounded blades.



101-8460

Plastic  
Orthopaedic  
Popular Model

101-8460 Angled 17 cm 6.75"



### König-STILLE nageluppklippnings sax | König-STILLE Nail-splitting Scissors

Nail-splitting scissors, for cutting up ingrown nails. Beveled blades.



101-8580

Plastic  
Orthopaedic  
Popular Model

101-8580 Straight 15 cm 6"



### Stevens-STILLE tenotomisax | Stevens-STILLE Tenotomy Scissors

Tenotomy scissors with rounded, very thin blades and tapered tips. Used in plastic surgery and hand surgery for cutting with extreme precision in small incisions.

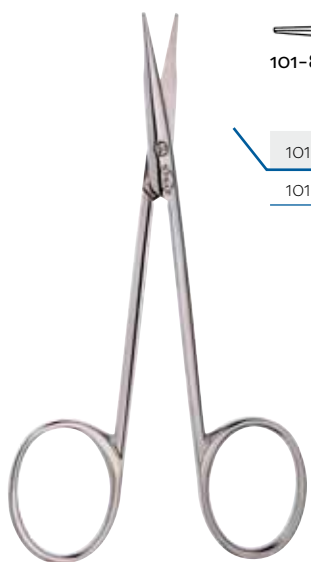

101-8166		101-8167	
101-8166	Straight	12.5 cm 5"	● ●
101-8167	Curved	12.5 cm 5"	● ●

Plastic  
 Orthopaedic  
 Popular Model

### Stevens-STILLE SuperCut XE tenotomisax | Stevens-STILLE SuperCut XE Tenotomy Scissors

Very popular SuperCut XE scissors for precise cutting and dissection of fine tissues. Rounded blades.

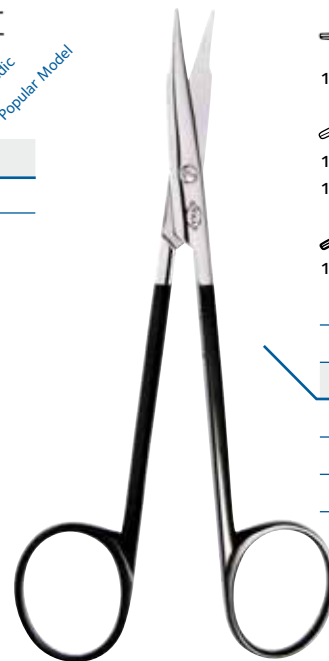

101-8166-1		101-8167-1	
101-8167-151		101-8170-1	
101-8167-181			
101-8171-1			
101-8166-1	Straight	12.5 cm 5"	● ● ●
101-8167-1	Curved	12.5 cm 5"	● ● ●
101-8167-151	Curved	15 cm 6"	● ● ●
101-8167-181	Curved	18 cm 7"	● ● ●
101-8170-1	Straight	9.5 cm 3.75"	●
101-8171-1	Curved	9.5 cm 3.75"	●

Plastic  
 Orthopaedic  
 Popular Model

## Stevens-STILLE SuperCut XE ergonomisk tenotomisax | Stevens-STILLE SuperCut XE Ergonomic Tenotomy Scissors

Ergonomic design of the popular Stevens SuperCut XE tenotomy scissors.

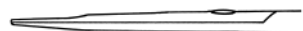

101-8166-2



101-8167-2



101-8167-152

101-8167-182

			Plastic	Orthopaedic	Popular Model
101-8166-2	Straight	12.5 cm 5"	●	●	
101-8167-2	Curved	12.5 cm 5"	●	●	●
101-8167-152	Curved	15 cm 6"	●	●	
101-8167-182	Curved	18 cm 7"	●	●	





## STILLE SuperCut XE kärlsax | STILLE SuperCut XE Vascular Scissors

Super Cut scissors with angled blades for better reach of vessels etc. Used in vascular surgery.

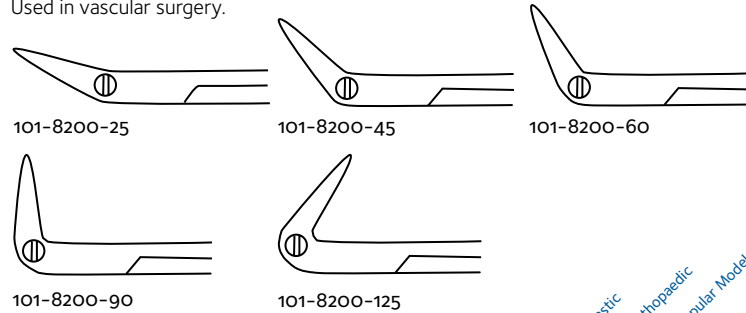

101-8200-25	Angled 25°	18 cm 7"
101-8200-45	Angled 45°	18 cm 7"
101-8200-60	Angled 60°	18 cm 7"
101-8200-90	Angled 90°	17 cm 6.75"
101-8200-125	Angled 125°	17 cm 6.75"

Plastic  
Orthopaedic  
Popular Model

## STILLE SuperCut XE kärlsax | STILLE SuperCut XE Vascular Scissors

Extra delicate version of the popular STILLE Vascular Scissor with shorter and thinner blades.

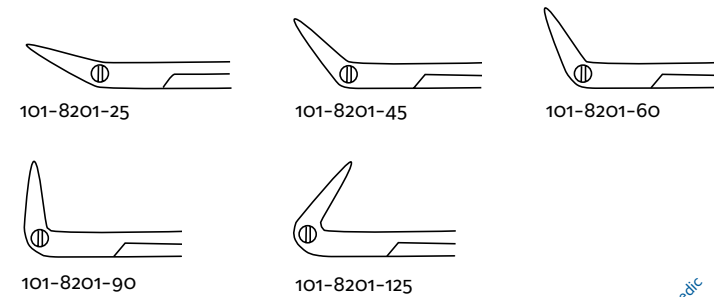

101-8201-25	Angled 25°	18 cm 7"	<b>NEW</b>
101-8201-45	Angled 45°	18 cm 7"	<b>NEW</b>
101-8201-60	Angled 60°	18 cm 7"	<b>NEW</b>
101-8201-90	Angled 90°	17 cm 6.75"	<b>NEW</b>
101-8201-125	Angled 125°	17 cm 6.75"	<b>NEW</b>

Plastic  
Orthopaedic  
Popular Model

Regarding new products, please see [www.stille.se](http://www.stille.se) for latest update. Product images to be added in next printed edition.

### Fomon STILLE nässax | Fomon STILLE Nasal Scissors

Scissors for rhinoplasty. Double-beveled blades.



101-8025

101-8025 Curved 12.5 cm 5"

Plastic  
Orthopaedic  
Popular Model

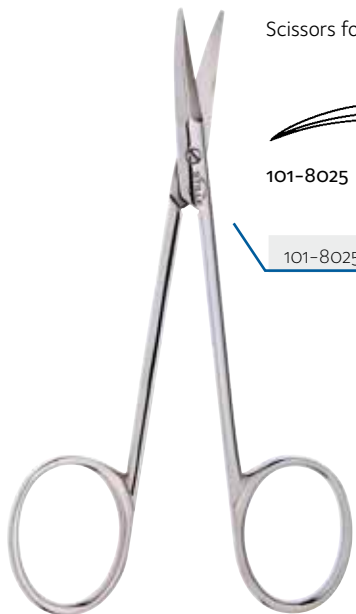

### Joseph STILLE nässax | Joseph STILLE Nasal Scissors

Nasal scissors for the lower lateral cartilage. Useful in dissecting and cutting tough tissue. Beveled blades.



101-8110

101-8110 Straight 15 cm 6"



101-8115

101-8115 Curved 15 cm 6"

Plastic  
Orthopaedic  
Popular Model

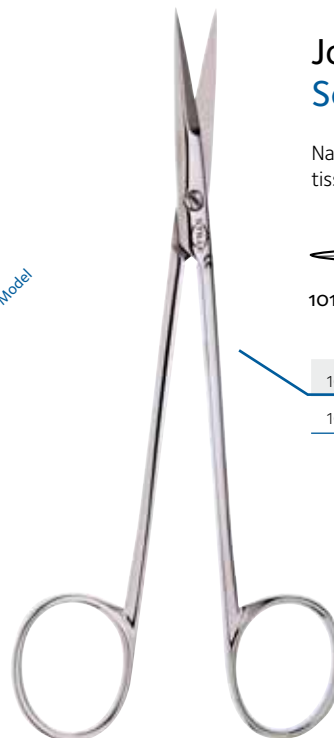

### Joseph STILLE SuperCut XE nässax | Joseph STILLE SuperCut XE Nasal Scissors

Super Cut nasal scissors for the lower lateral cartilage. Useful in dissecting and cutting tough tissue. Beveled blades.



101-8110

101-8110-1 Straight 15 cm 6"



101-8115

101-8115-1 Curved 15 cm 6"

Plastic  
Orthopaedic  
Popular Model



### Peck-Joseph STILLE nässax | Peck-Joseph STILLE Nasal Scissors

Double-beveled scissors for rhinoplasty.

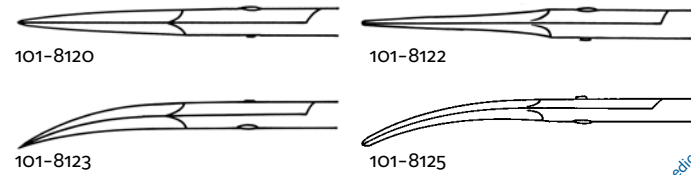

101-8120	Sharp	Straight	15 cm 6"	●
101-8122	Blunt	Straight	15 cm 6"	●
101-8123	Sharp	Curved	15 cm 6"	●
101-8125	Blunt	Curved	15 cm 6"	●

Plastic  
Orthopaedic  
Popular Model

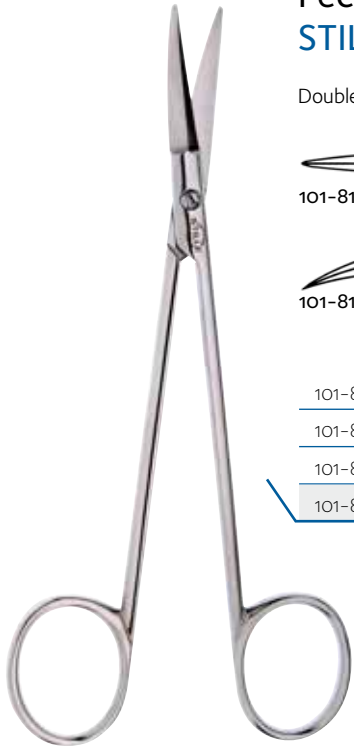

### Peck-Joseph STILLE SuperCut XE nässax | Peck-Joseph STILLE SuperCut XE Nasal Scissors

Double-beveled scissors for rhinoplasty.

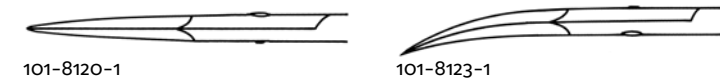

101-8120-1	Sharp	Straight	15 cm 6"	●
101-8123-1	Sharp	Curved	15 cm 6"	●

Plastic  
Orthopaedic  
Popular Model



## STILLE SuperCut XE nässax | STILLE SuperCut XE Nasal Scissors

SuperCut XE nasal scissors for excision of cartilage.

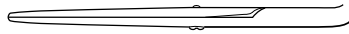

101-8411

101-8411	Straight	Angled shanks	18 cm 7"	●
----------	----------	---------------	----------	---

Plastic  
Orthopaedic  
Popular Model



## STILLE Caplan SuperCut XE nässax | STILLE Caplan SuperCut XE Nasal Scissors

Nasal shears with double-action joint for increased cutting power. Serrated TC-blades for use on tough tissue. Angled shanks.

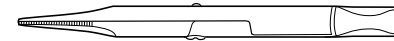

101-8417

101-8417	Straight	Serrated	TC-inserts	20cm 8"	NEW ●
----------	----------	----------	------------	---------	-------

Plastic  
Orthopaedic  
Popular Model

Regarding new products, please see [www.stille.se](http://www.stille.se) for latest update. Product images to be added in next printed edition.

### STILLE Fomon SuperCut XE nässax | STILLE Fomon SuperCut XE Nasal Scissors

Serrated SuperCut XE scissors for cutting dorsal cartilage. Angled shanks for better visibility.



101-8425

Plastic  
Orthopaedic  
Popular Model

101-8425 Serrated blades Angled shanks 14 cm 5.5" ●



### STILLE Cottle SuperCut XE nässax | STILLE Cottle SuperCut XE Nasal Scissors

SuperCut XE scissors with heavy blades for cutting dorsal cartilage. Angled shanks for better visibility. Serrated blades.

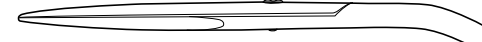

101-8604

Plastic  
Orthopaedic  
Popular Model

101-8604 Serrated blades Angled shanks 16 cm 6.25" ●



### Gorney STILLE SuperCut XE Face-lift sax | Gorney STILLE SuperCut XE Face-lift scissors

Super Cut double-beveled face-lift scissors with flat tips and semi-sharp outer blades. Two models with serrated blades to prevent tissue slippage.

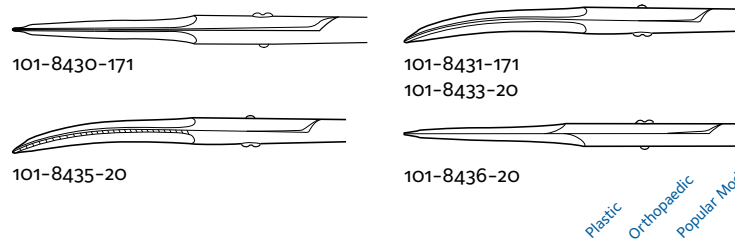

101-8430-171	Straight		17 cm 6.75"	●
101-8431-171	Curved		17 cm 6.75"	●
101-8433-20	Curved		20 cm 8"	●
101-8435-20	Curved	Serrated	20 cm 8"	●
101-8436-20	Straight	Serrated	20 cm 8"	●

Plastic  
Orthopaedic  
Popular Model



### Gorney STILLE SuperCut XE ergonomisk Face-lift sax | Gorney STILLE SuperCut XE Ergonomic Face-lift scissors

Ergonomic design to avoid fatigue in the hand. One model with serrated blades to prevent tissue slippage. Flat tips and semi-sharp outer blades.

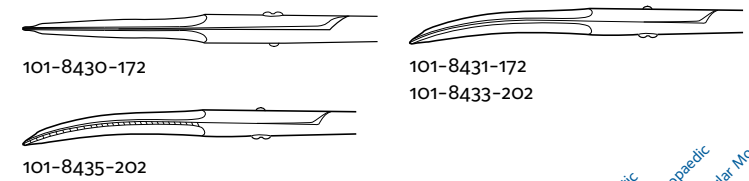

101-8430-172	Straight		17 cm 6.75"	●
101-8431-172	Curved		17 cm 6.75"	●
101-8433-202	Curved		20 cm 8"	●
101-8435-202	Curved	Serrated	20 cm 8"	●

Plastic  
Orthopaedic  
Popular Model

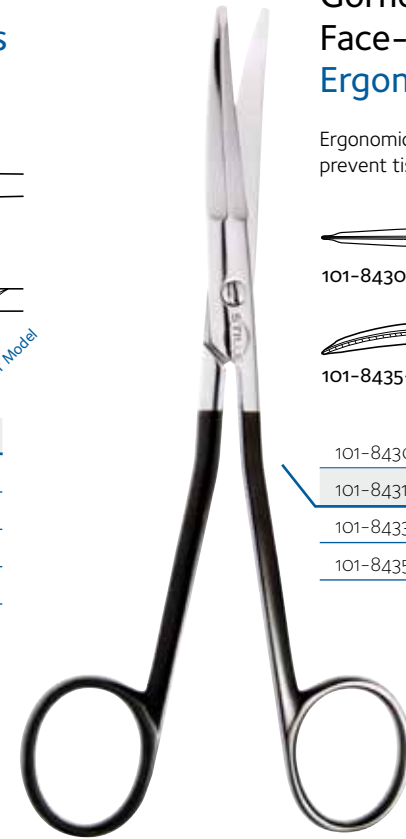

### Aston STILLE SuperCut XE Face-lift sax | Aston STILLE SuperCut XE Face-lift scissors

Double-beveled SuperCut XE face-lift scissors with semi-sharp outer blades for undermining flaps.

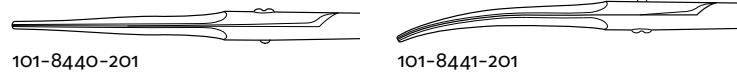

101-8440-201

101-8441-201



101-8442-171

101-8440-201	Straight		20 cm 8 in	●
101-8441-201	Curved		20 cm 8 in	●
101-8442-171	Curved	Serrated	17 cm 6.75 in	●

Plastic  
Orthopaedic  
Popular Model



### Davis STILLE SuperCut XE Face-lift sax | Davis STILLE SuperCut XE Face-lift Scissors

SuperCut XE face-lift scissors with tapered blades and sharp tips for precise cutting and dissection.



101-8452

101-8452	Curved	18 cm 7"	●
----------	--------	----------	---

Plastic  
Orthopaedic  
Popular Model



### Rees STILLE SuperCut XE Face-lift sax | Rees STILLE SuperCut XE Face-lift scissors

SuperCut XE face-lift scissors, double-beveled with semi-sharp outer blades for undermining skin flaps.



101-8456-171

101-8456-171	Curved	17 cm 6.75"	●		
--------------	--------	-------------	---	--	--

Plastic  
Orthopaedic  
Popular Model



### Matarasso STILLE SuperCut XE Face-lift sax | Matarasso STILLE SuperCut XE Face-lift scissors

SuperCut XE face-lift scissors with double-beveled semi-sharp outer blades.



101-8458

101-8459-20

101-8458-17	Curved	17 cm 6.75"	●		
101-8458-20	Curved	20 cm 8"	●	●	
101-8459-20	Straight	20 cm 8"	●		

Plastic  
Orthopaedic  
Popular Model



### Matarasso STILLE SuperCut XE ergonomisk Face-lift sax | Matarasso STILLE SuperCut XE Ergonomic Face-lift scissors

Ergonomic version of the Matarasso SuperCut XE face-lift scissors with double-beveled semi-sharp outer blades.



101-8458

101-8458-172	Curved	17 cm 6.75"	●		
101-8458-202	Curved	20 cm 8"	●		

Plastic  
Orthopaedic  
Popular Model





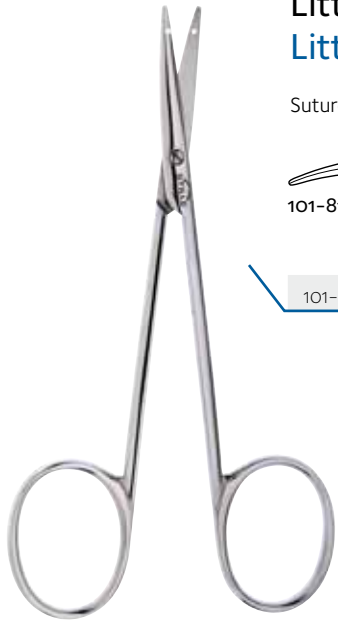

### Littler STILLE trådföringssax | Littler STILLE Suture carrying scissors

Suture carrying scissors. Rounded blades.



101-8164

101-8164	Curved	12.5 cm 5"	<input checked="" type="checkbox"/>	<input checked="" type="checkbox"/>
----------	--------	------------	-------------------------------------	-------------------------------------

Plastic  
Orthopaedic  
Popular Model

### STILLE sutursax | STILLE Suture scissors

Suture removal scissors.



101-8584

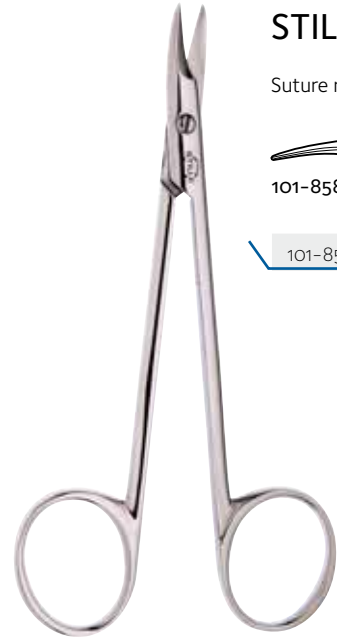

101-8584 Curved 13.5 cm 5.25"

Plastic  
Orthopaedic  
Popular Model

### Spencer STILLE sutursax | Spencer STILLE Suture scissors

Popular suture scissors for many procedures. Delicate model.

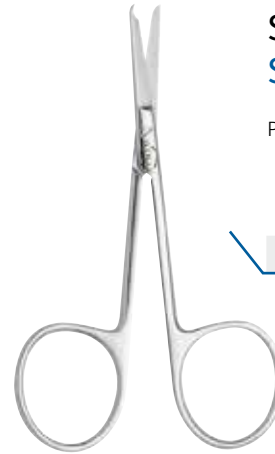

101-8586-9 9 cm 3.5" **NEW**

Plastic  
Orthopaedic  
Popular Model



### Lister STILLE TC bandagesax | Lister STILLE TC Bandage Scissors

Bandage scissors with TC-inserts for improved durability.

101-8595-18 TC-inserts 18 cm 7" **NEW**

Plastic  
Orthopaedic  
Popular Model



### Littauer STILLE sutursax | Littauer STILLE Suture scissors

A somewhat larger model than Spencer. Used in many procedures.

101-8597-14	Delicate pattern	14 cm 5.5"	<b>NEW</b>	<input checked="" type="checkbox"/> Plastic <input checked="" type="checkbox"/> Orthopaedic <input checked="" type="checkbox"/> Popular Model
-------------	------------------	------------	------------	---

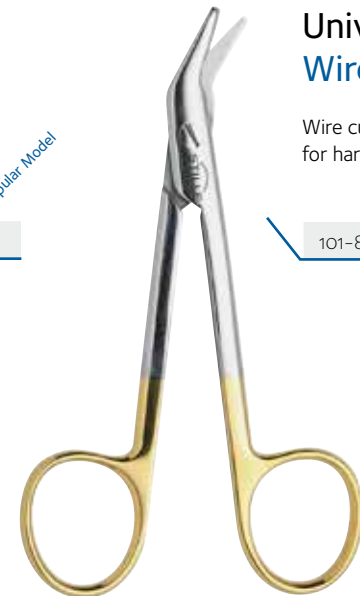

### Universal STILLE ståltrådsax | Universal STILLE Wire Cutting scissors

Wire cutting scissors with TC-inserts. For soft wire up to 1.2 mm, for hard wire up to 0.8 mm.

101-8815-12	TC	12 cm 4.75"	<b>NEW</b>	<input checked="" type="checkbox"/> Plastic <input type="checkbox"/> Orthopaedic <input type="checkbox"/> Popular Model
-------------	----	-------------	------------	---



**AS AN EXTENSION OF THE SURGEON'S THUMB** and forefinger, forceps need to grasp and release with the same sensitivity as a pair of fingertips. The claws on surgical forceps are specially designed to make a firm, yet gentle, grasp of the tissue. The anatomical forceps are designed, as much as possible, to take an atraumatic grip on sensitive tissue.

It is the fine tuning that creates the perfect balance with a smooth, resilient spring action and a firm grip. The surface grooves increase gripping power even further. This gives the surgeon full control while causing as little harm to the tissue as possible.

Forceps are among the surgical instruments that founder Albert Stille learned to make from scratch during his apprenticeship in the 1830's. Forceps are seemingly simple instrument but still demands ultra-precision in the manufacturing process. Over the years, STILLE's forceps continue to be refined and are today recognized for their unique feel and excellent balance in combination with unsurpassed longevity.

**SOM EN FÖRLÄNGNING** av kirurgens tumme och pekfinger måste pincetten kunna fatta och släppa taget med samma känslighet som hos ett par fingertoppar. Klorna på de kirurgiska pincetterna är därför speciellt formgivna för att fatta ett fast, men ändå mildt, grepp om vävnaden. De anatomiska pincetterna är tillverkade för att kunna ta ett så atraumatiskt grepp som möjligt om känslig vävnad.

Det är finjusteringen som skapar den perfekta balansen med ett följsamt, fjädrande motstånd och ett stadigt grepp. Den karrerade ytan ökar greppbarheten ytterligare. Det ger kirurgen full kontroll samtidigt som det orsakar så lite skada på vävnaden som möjligt.

Pincetten hör till de kirurgiska instrument som grundaren Albert Stille lärde sig att tillverka från grunden redan under sina lärlingsår på 1830-talet. Ett till synes enkelt hjälpmedel som dock kräver exakt precision vid tillverkningen. Genom åren har STILLES pincetter fortsatt att förfinas och de är idag erkända för sin unikt mjuka känsla och goda balans i kombination med sin oöverträffade livslängd.



# Pincetter | Forceps | Pinzetten | Pinze | Pinzas | 鑷子 (ピンセット)

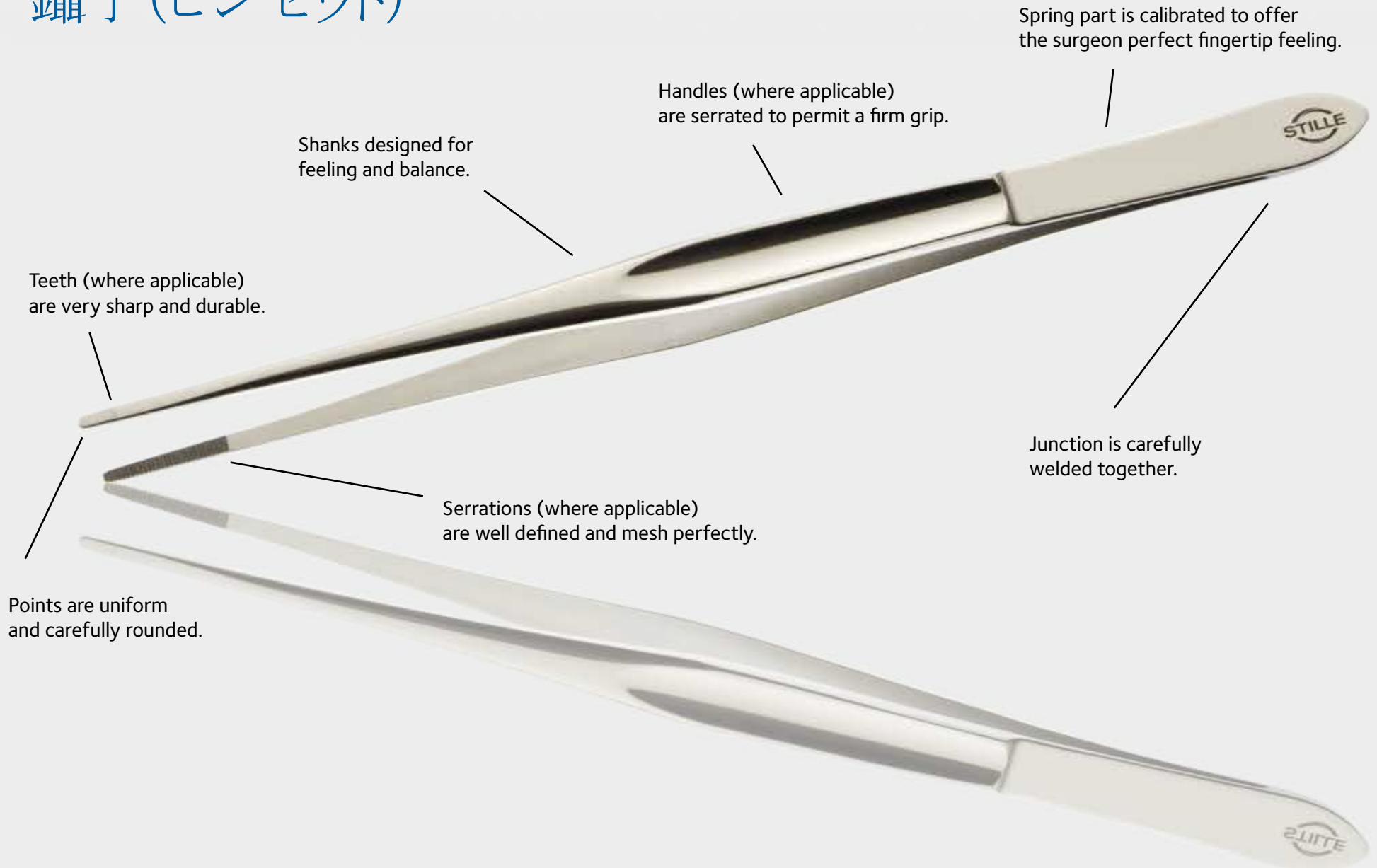



### Adson STILLE pincett | Adson STILLE Tissue Forceps

Tissue forceps with very delicate points and 1x2 fine teeth. Used in most specialties for delicate work.

102-9019		102-9022						
		102-9022-15						
102-9019	Very delicate	1x2 teeth	12 cm 4.75"	●	●			
102-9022	Cross-serrated	1x2 teeth	12 cm 4.75"	●	●	●		
102-9022-15	Cross-serrated	1x2 teeth	15 cm 6"	●	●			



### Adson-Callison STILLE pincett | Adson-Callison STILLE Tissue Forceps

Tissue forceps with tying platform and 1x2 fine teeth.

102-9021		102-9021-1						
102-9021	Tying platform	1x2 teeth	12 cm 4.75"	●	●	●		
102-9021-1	Delicate tying platform	1x2 teeth	12 cm 4.75"	●	●	●		



### Adson-Brown STILLE pincett | Adson-Brown STILLE Tissue Forceps

Tissue forceps with side-grasping teeth for secure, atraumatic grasping of soft tissue or cartilage.

102-9023-12								
102-9023-12	Side-grasping teeth		12 cm 4.75"	●	●			

### Gillies STILLE pincett | Gillies STILLE Tissue Forceps

Tissue forceps with 1x2 fine teeth and stabilizing pin. An excellent forceps for the surgeon who wants an Adson-size tip, but with greater length.

102-9027								
102-9027	Serrated	1x2 fine teeth	15,5 cm 6.25"	●	●	●		



### STILLE pincett | STILLE Tissue Forceps

Tissue forceps with 1x2 fine teeth and stabilizing pin. Delicate model.



102-9028

102-9028	Serrated	1x2 fine teeth	15.5 cm 6.25"	●	●	●
----------	----------	----------------	---------------	---	---	---

Plastic  
Orthopaedic  
Popular Model



### STILLE pincett | STILLE Tissue Forceps

Tissue forceps with 1x2 teeth.



102-9060

102-9060-15	1x2 teeth	15 cm 6"	●	●	●
102-9060-17	1x2 teeth	17 cm 6.75"	●	●	●
102-9060-20	1x2 teeth	20 cm 8"	●	●	

Plastic  
Orthopaedic  
Popular Model



### STILLE pincett | STILLE Tissue Forceps

Tissue forceps with 1x2 fine teeth.



102-9050-13

102-9050-13	1x2 fine teeth	13 cm 5"	●	●	
-------------	----------------	----------	---	---	--

Plastic  
Orthopaedic  
Popular Model



### STILLE pincett | STILLE Tissue Forceps

Tissue forceps with 2x3 teeth. Used when more grasping power than 1x2 teeth is needed.



102-9062

102-9062-15	2x3 teeth	15 cm 6"	●	●	
102-9062-17	2x3 teeth	17 cm 6.75"	●		
102-9062-20	2x3 teeth	20 cm 8"	●		

Plastic  
Orthopaedic  
Popular Model





### Adlercreutz STILLE pincett | Adlercreutz STILLE Tissue Forceps

Tissue forceps with 4x5 fine teeth. Very useful in neurosurgery to hold the dura, and in cardiovascular surgery to hold the pericardium.

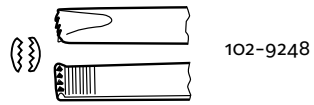

			Plastic	Orthopaedic	Popular Model
102-9248-15	4x5 fine teeth	15 cm 6"	●		
102-9248-20	4x5 fine teeth	20 cm 8"	●		
102-9248-25	4x5 fine teeth	25 cm 10"	●		

### Waugh-Brophy STILLE pincett | Waugh-Brophy STILLE Tissue Forceps

Tissue forceps with 1x2 fine teeth. Very fine tips, like Adson. Useful when long and slender instruments are needed.



				Plastic	Orthopaedic	Popular Model
102-9252-20	1x2 teeth	Cross-serrated	20 cm 8"	●	●	●
102-9252-25	1x2 teeth	Cross-serrated	25 cm 10"	●	●	●
102-9252-30	1x2 teeth	Cross-serrated	30 cm 12"		●	



### Russian STILLE pincett | Russian STILLE Tissue Forceps

Forceps for secure grip of tissue. Used when a better grip than with a dressing forceps is needed, and when damage to the tissue must be avoided. For hard and slippery tissue.

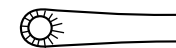

		Plastic	Orthopaedic	Popular Model
102-9270-20	20 cm 8"		●	







### Adson STILLE anatomisk pincett | Adson STILLE Dressing Forceps

General-purpose dressing forceps with various types of jaw surfaces.

102-9020 102-9020-15	102-9020-1	102-9024		Plastic Orthopaedic Popular Model	
102-9020	Serrated	12 cm 4.75"	•	•	•
102-9020-15	Serrated	15 cm 6"	•	•	
102-9020-1	Diamond jaws	12 cm 4.75"	•	•	
102-9024	TC jaws cross-serrated	12 cm 4.75"	•	•	



### McIndoe STILLE anatomisk pincett | McIndoe STILLE Dressing Forceps

Dressing forceps with stabilizing pin and delicate jaws for grasping fine tissue.

102-9025	102-9025-1			Plastic Orthopaedic Popular Model	
102-9025	Serrated	15,5 cm 6.25"	•	•	•
102-9025-1	Diamond Jaws	15,5 cm 6.25"	•	•	

### STILLE anatomisk pincett | STILLE Dressing Forceps

Dressing forceps with square shaped and serrated points used in all surgical specialties.

	102-9030				
				Plastic Orthopaedic Popular Model	
102-9030-13	Square points	13 cm 5"	•	•	
102-9030-15	Square points	15 cm 6"	•	•	•
102-9030-17	Square points	17 cm 6.75"	•	•	•
102-9030-20	Square points	20 cm 8"	•	•	•
102-9030-25	Square points	25 cm 10"	•	•	•



### STILLE anatomisk pincett | STILLE Dressing Forceps

Dressing forceps with rounded points and serrated jaws.

	102-9040				
				Plastic Orthopaedic Popular Model	
102-9040-15	Rounded points	15 cm 6"	•	•	
102-9040-17	Rounded points	17 cm 6.75"	•	•	
102-9040-20	Rounded points	20 cm 8"	•	•	•
102-9040-25	Rounded points	25 cm 10"	•	•	•
102-9040-30	Rounded points	30 cm 12"	•	•	





### Crafoord-STILLE anatomisk pincett | Crafoord-STILLE Dressing Forceps

Dressing forceps with rounded points. The perfect balance and delicate grip gives this instrument a unique feeling.

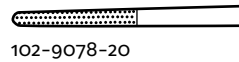
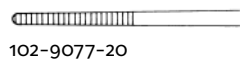

Model	Jaw Type	Length	Plastic	Orthopaedic	Popular Model
102-9077-20	Serrated	20 cm 8"	●	●	●
102-9078-20	Diamond jaws	20 cm 8"	●	●	

Plastic  
Orthopaedic  
Popular Model



### Waugh-Brophy STILLE anatomisk pincett | Waugh-Brophy STILLE Dressing Forceps

Dressing forceps with very fine points and two different jaw surfaces. The cross-serration gives excellent holding power.

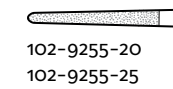
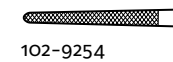

Model	Jaw Type	Length	Plastic	Orthopaedic	Popular Model
102-9254	Cross-serrated	20 cm 8"	●	●	●
102-9255-20	Diamond jaws	20 cm 8"	●	●	
102-9255-25	Diamond jaws	25 cm 10"	●	●	

Plastic  
Orthopaedic  
Popular Model



## Olivecrona-STILLE durapincett | Olivecrona-STILLE Dura Forceps

Dura forceps with 2x3 fine teeth. The nonpenetrating tips give the surgeon maximum grip without damaging the tissue.



Plastic  
Orthopaedic  
Popular Model

102-9244-15	2x3 fine teeth	15 cm 6"	
102-9244-20	2x3 fine teeth	20 cm 8"	●
102-9244-25	2x3 fine teeth	25 cm 10"	



## STILLE irispincett | STILLE Iris Forceps

Short delicate forceps with either 1x2 fine teeth or serrated jaws.

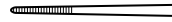

102-9460

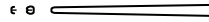

102-9470

Plastic  
Orthopaedic  
Popular Model

102-9460	Serrated	10 cm 4"	●
102-9470	1x2 teeth	10 cm 4"	●



### STILLE De Bakey kärlpincett | STILLE De Bakey Vascular Forceps

Atraumatic forceps with De Bakey jaws for handling of blood vessels and other delicate tissue. Can be insulated on request.

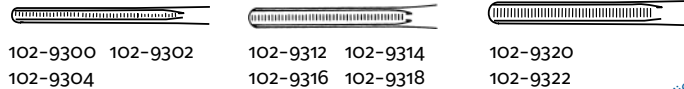

102-9300 102-9302 102-9312 102-9314 102-9320  
102-9304 102-9316 102-9318 102-9322

Plastic  
Orthopaedic  
Popular Model

102-9340	De Bakey type	1 mm	15 cm 6"	<b>NEW</b>	
102-9342	De Bakey type	1 mm	20 cm 8"	<b>NEW</b>	
102-9354	De Bakey type	1.5 mm	25 cm 10"	<b>NEW</b>	
102-9300	De Bakey type	2 mm	15 cm 6"		●
102-9302	De Bakey type	2 mm	20 cm 8"		●
102-9304	De Bakey type	2 mm	25 cm 10"		●
102-9312	De Bakey type	2.7 mm	15 cm 6"		●
102-9314	De Bakey type	2.7 mm	20 cm 8"		●
102-9316	De Bakey type	2.7 mm	25 cm 10"		●
102-9318	De Bakey type	2.7 mm	30 cm 11.75"		
102-9320	De Bakey type	3.2 mm	20 cm 8"		
102-9322	De Bakey type	3.2 mm	25 cm 10"		●



### STILLE De Bakey kärlpincett | STILLE De Bakey Vascular Forceps

Angled atraumatic forceps with De Bakey jaws for delicate tissue.

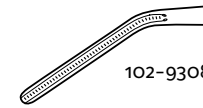

102-9308 De Bakey type 2 mm 20 cm 8"

Plastic  
Orthopaedic  
Popular Model



### STILLE De Bakey kärlpincett | STILLE De Bakey Vascular Forceps

Atraumatic forceps with De Bakey jaws for delicate tissue, non serrated handles. Stop pin for preventing from gripping the tissue too hard.



102-9330

102-9330 De Bakey type 2 mm 20 cm 8"

Plastic  
Orthopaedic  
Popular Model



**Waugh-Brophy STILLE isolerad diatermipincett | Waugh-Brophy STILLE insulated Diathermy Forceps**

Insulated version of the popular Waugh-Brophy forceps. Used in monopolar diathermy with 1x2 teeth.



102-9852

						Plastic	Orthopaedic	Popular Model
102-9852-20	1x2 teeth	Cross-serrated	20 cm 8"	<b>NEW</b>	●	●		
102-9852-25	1x2 teeth	Cross-serrated	25 cm 10"	<b>NEW</b>	●	●		
102-9852-30	1x2 teeth	Cross-serrated	30 cm 12"	<b>NEW</b>			●	

**Waugh-Brophy STILLE isolerad diatermipincett | Waugh-Brophy STILLE insulated Diathermy Forceps**

Insulated version of the popular Waugh-Brophy forceps. Used in monopolar diathermy.



102-9855

						Plastic	Orthopaedic	Popular Model
102-9855-20		Cross-serrated	20 cm 8"	<b>NEW</b>	●	●		
102-9855-25		Cross-serrated	25 cm 10"	<b>NEW</b>	●	●		

**Björk-STILLE diatermipincetter | Björk-STILLE Diathermy Forceps**

Insulated forceps for monopolar diathermy. Serrations allow grasping of delicate structures.

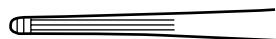

102-9845

						Plastic	Orthopaedic	Popular Model
102-9845-15	Insulated		15 cm 6"		●	●		
102-9845-20	Insulated		20 cm 8"		●	●	●	
102-9845-25	Insulated		25cm 10"		●	●	●	



Regarding new products, please see [www.stille.se](http://www.stille.se) for latest update. Product images to be added in next printed edition.



## Björk–STILLE knutpincett | Björk–STILLE Knot-Holding Forceps

Same as Björk–STILLE diathermy forceps, but without insulation.



102-9846-20

102-9846-20	20 cm 8 in	<input checked="" type="checkbox"/>	<input checked="" type="checkbox"/>	<input checked="" type="checkbox"/>
-------------	------------	-------------------------------------	-------------------------------------	-------------------------------------

Plastic  
Orthopaedic  
Popular Model



**STILLES PEANGER** har en unik och gracil design med mjuka former, alltid med kirurgens specifika behov i fokus. Det öppna boxlåset förenklar rengöringen och minimerar risken för att kirurgens handskar eller suturer ska fastna i instrumentet. Utformningen av det speciella knäppet är unik och håller alltid peangen stängd i en säker position. Samtidigt är knäppet mycket lätt och smidigt att öppna så att kirurgen hela tiden har full kontroll.

Käftarna har rundade kanter och perfekt passform mot varandra. Det finns ingen risk för att de ska släppa greppet. Peangen stängs och öppnas lika snabbt och smidigt med ett enkelt handgrepp. Därför upplevs den som mycket mjukare och med en spänst som inga andra fabrikat kan erbjuda.

Konstruktionen har fortsatt att förbättras under årens lopp och många försök har gjorts att kopiera STILLES egenutvecklade design. Den oöverträffade livslängden gör peangerna till en god investering som kan användas under många år.

**STILLE'S ARTERY FORCEPS** have a unique and graceful design featuring soft shapes, always with the surgeon's specific needs in mind. The open box lock simplifies cleaning and minimizes the risk of the surgeon's gloves or sutures becoming entangled in the instrument. The design of the special ratchet is unique and always keeps the forceps closed in a secure position. At the same time the ratchet is very easy and convenient to open, giving the user full control.

The jaws have rounded edges and fit perfectly together. There is no risk of losing grip. The instrument closes and opens quickly and smoothly with a simple operation. STILLE artery forceps have a softer feel with performance properties that no other brand can offer.

The manufacturing technique has continued to improve over the years and many attempts have been made to imitate STILLE's proprietary design. The unsurpassed longevity makes these instruments a good investment that will be in service for many years.





Peanger | Artery forceps | Arterienklemmen |  
Pinze emostatiche | Pinzas hemostáticas | 止血鉗子

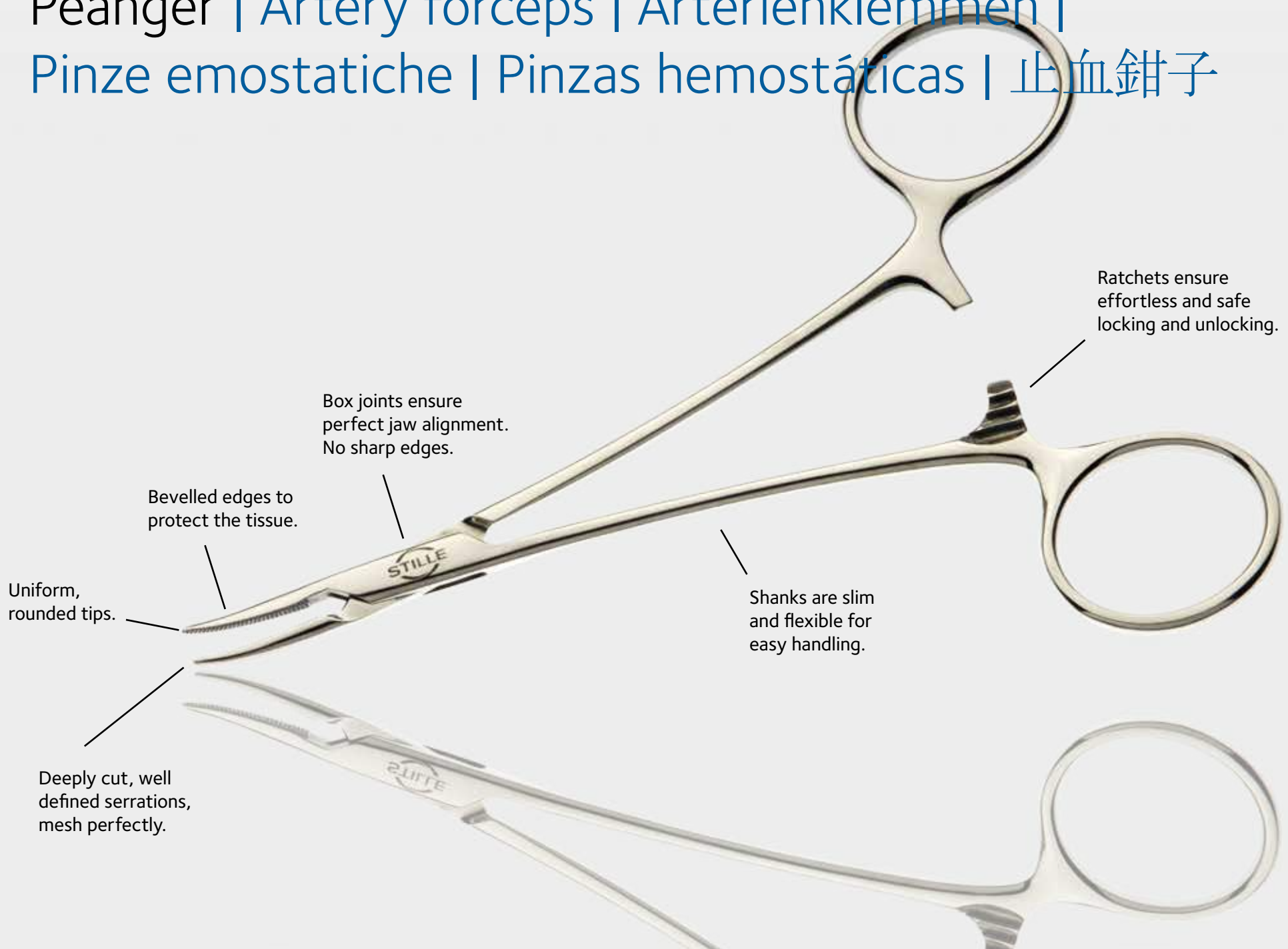

Ratchets ensure effortless and safe locking and unlocking.

Box joints ensure perfect jaw alignment. No sharp edges.

Bevelled edges to protect the tissue.

Uniform, rounded tips.

Shanks are slim and flexible for easy handling.

Deeply cut, well defined serrations, mesh perfectly.



### Pean STILLE peang | Pean STILLE Artery Forceps

General utility forceps used in many surgical disciplines.

103-10015-131	Straight	13.5 cm 5.25"	NEW	● Plastic	● Orthopaedic	● Popular Model
---------------	----------	---------------	-----	-----------	---------------	-----------------

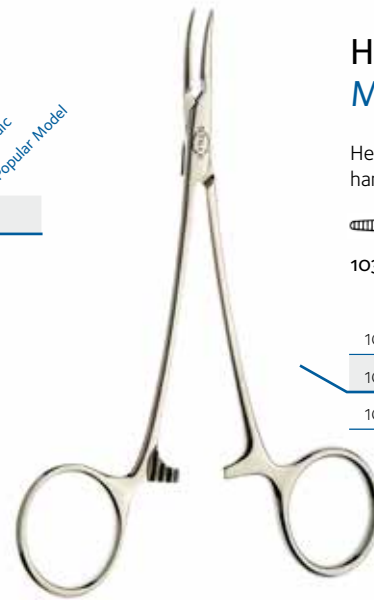

### Halsted-Mosquito STILLE peang | Halsted-Mosquito STILLE Artery Forceps

Hemostat without teeth, used in small operative fields. For plastic surgery, neuro, hand or any delicate surgery.

	103-10030-121	Straight	12 cm 4.75"	● Plastic	● Orthopaedic	● Popular Model
	103-10032-121	Curved	12 cm 4.75"	● Plastic	● Orthopaedic	● Popular Model
	103-10032-181	Curved	18 cm 7"	● Plastic	● Orthopaedic	● Popular Model

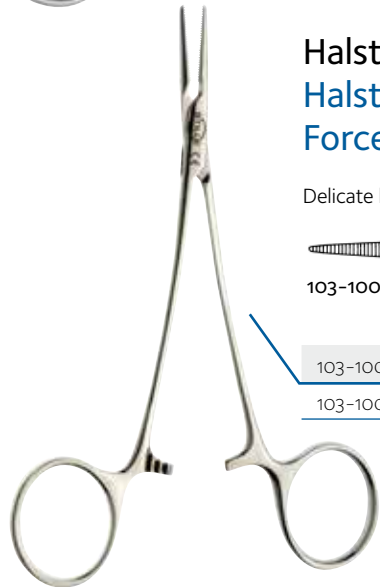

### Halsted-Mosquito STILLE gracil peang | Halsted-Mosquito STILLE delicate Artery Forceps

Delicate hemostat without teeth for small operating field.

	103-10026-121	Straight	12 cm 4.75"	● Plastic	● Orthopaedic	● Popular Model
	103-10028-121	Curved	12 cm 4.75"	● Plastic	● Orthopaedic	● Popular Model

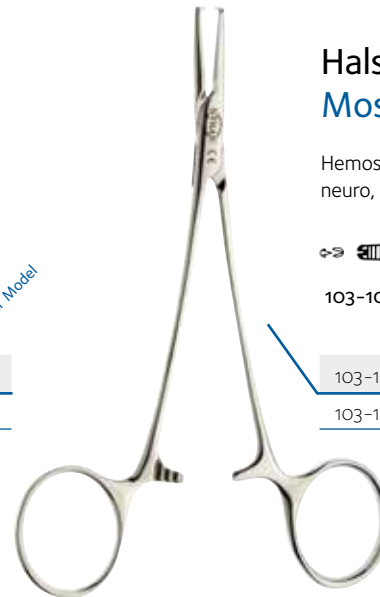

### Halsted-Mosquito STILLE peang | Halsted-Mosquito STILLE Artery Forceps

Hemostat with 1x2 teeth, used in small operative fields. For plastic surgery, neuro, hand or any delicate surgery.

	103-10035-121	1x2 teeth	Straight	12 cm 4.75"	● Plastic	● Orthopaedic	● Popular Model
	103-10037-121	1x2 teeth	Curved	12 cm 4.75"	● Plastic	● Orthopaedic	● Popular Model

### Kocher STILLE peang | Kocher STILLE Artery Forceps

Hemostat with 1x2 teeth. Widely used when a short instrument is needed. Can also be used as tissue forceps to retract or lift an organ.



103-10115-141

				Plastic	Orthopaedic	Popular Model
103-10115-141	1x2 teeth	Straight	14 cm 5.5"	●	●	
103-10117-141	1x2 teeth	Curved	14 cm 5.5"	NEW	●	●



### Kelly STILLE peang | Kelly STILLE Artery Forceps

Fairly short hemostat with jaws, half-serrated.

				Plastic	Orthopaedic	Popular Model
103-10150-141	Straight	14 cm 5.5"	NEW	●	●	
103-10152-141	Curved	14 cm 5.5"	NEW	●	●	





### Kelly-Rankin STILLE peang | Kelly-Rankin STILLE Artery Forceps

Longer version of the Kelly hemostat with jaws half-serrated.

				Plastic	Orthopaedic	Popular Model
103-10160-161	Straight	16 cm 6.25"	NEW	●	●	
103-10162-161	Curved	16 cm 6.25"	NEW	●	●	

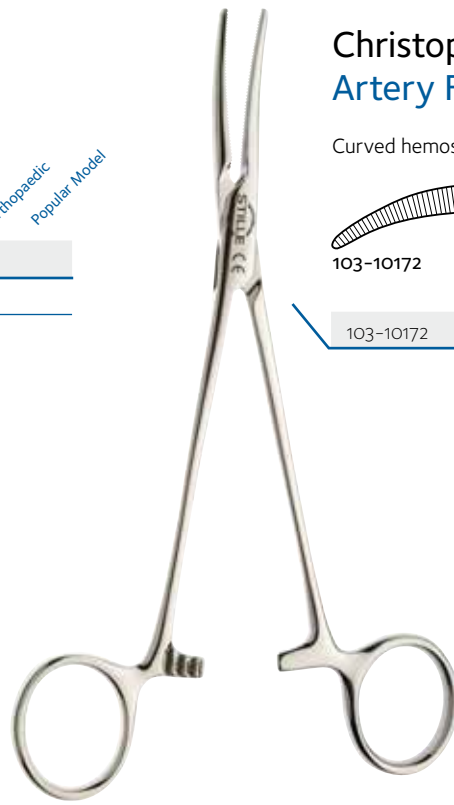

### Christophe-STILLE peang | Christophe-STILLE Artery Forceps

Curved hemostat without teeth.

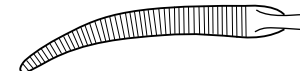

103-10172

				Plastic	Orthopaedic	Popular Model
103-10172	Curved	16 cm 6.25"		●	●	

### Crile STILLE peang | Crile STILLE Artery Forceps

General purpose hemostat without teeth. Used in relatively small operating fields, when more strength is needed than a Mosquito can offer.

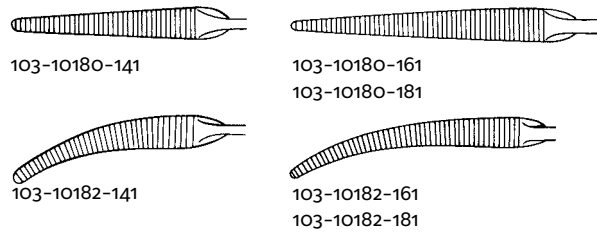

			Plastic	Orthopaedic	Popular Model
103-10180-141	Straight	14 cm 5.5"	●	●	
103-10180-161	Straight	16 cm 6.25"	●	●	
103-10180-181	Straight	18 cm 7"	●	●	
103-10182-141	Curved	14 cm 5.5"	●	●	●
103-10182-161	Curved	16 cm 6.25"	●	●	●
103-10182-181	Curved	18 cm 7"	●	●	●



### Crile STILLE peang | Crile STILLE Artery Forceps

General purpose hemostat with 1x2 teeth. Used in relatively small operating fields, when more strength is needed than a Mosquito can offer.

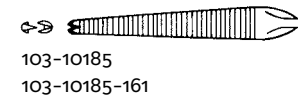

					Plastic	Orthopaedic	Popular Model
103-10185	1x2 teeth	Straight	14 cm 5.5"		●	●	
103-10185-161	1x2 teeth	Straight	16 cm 6.25"	NEW	●	●	
103-10187-141	1x2 teeth	Curved	14 cm 5.5"	NEW	●	●	
103-10187-161	1x2 teeth	Curved	16 cm 6.25"	NEW	●	●	



### Leriche STILLE peang | Leriche STILLE Artery Forceps

Fairly tapered hemostat. For use in small operative fields.

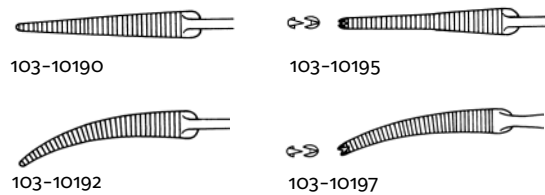

Model	Teeth	Shape	Length	Plastic	Orthopaedic	Popular Model
103-10190		Straight	15 cm 6"	●		
103-10192		Curved	15 cm 6"	●	●	
103-10195	1x2 teeth	Straight	15 cm 6"	●		
103-10197	1x2 teeth	Curved	15 cm 6"	●		



### Rochester-Péan STILLE peang | Rochester-Péan STILLE Artery Forceps

Sturdy hemostat. Relatively blunt tips. Used in all types of surgery.

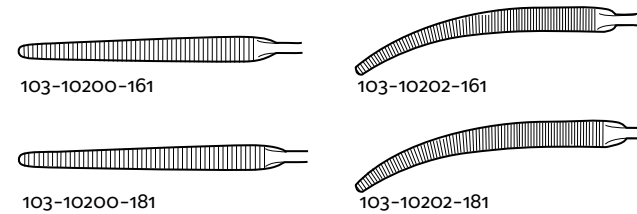

Model	Shape	Length	Plastic	Orthopaedic	Popular Model
103-10200-161	Straight	16 cm 6.25"	●	●	
103-10200-181	Straight	18 cm 7"	●	●	
103-10202-161	Curved	16 cm 6.25"	●	●	
103-10202-181	Curved	18 cm 7"	●	●	●



### Rochester-Ochsner STILLE peang | Rochester-Ochsner STILLE Artery Forceps

Sturdy hemostat with 1x2 teeth. Used when a strong forceps is needed, both to occlude blood vessels and to lift or retract organs.

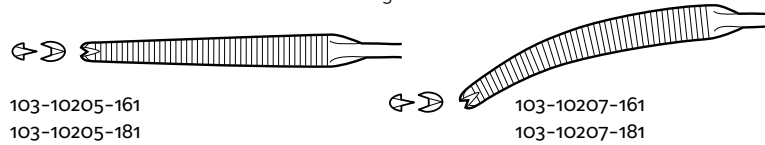

				Plastic	Orthopaedic	Popular Model
103-10205-161	1x2 teeth	Straight	16 cm 6.25"	●	●	●
103-10205-181	1x2 teeth	Straight	18 cm 7"	●	●	●
103-10207-161	1x2 teeth	Curved	16 cm 6.25"	●	●	●
103-10207-181	1x2 teeth	Curved	18 cm 7"	●	●	



### Rochester-Péan STILLE peang | Rochester-Péan STILLE Artery Forceps

Sturdy hemostats. The 20 cm has short and the 24 cm has long jaws. Also referred to as hysterectomy forceps.

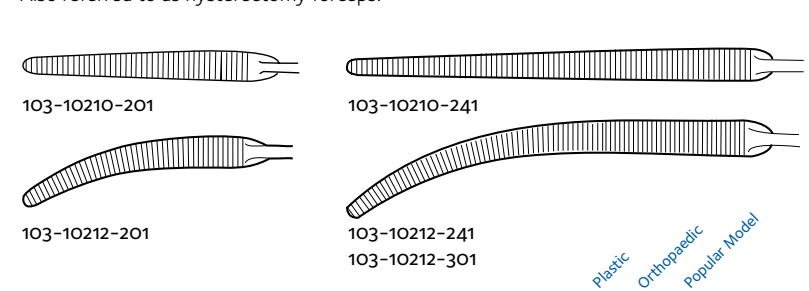

				Plastic	Orthopaedic	Popular Model
103-10210-201	Straight	20 cm 8"		●	●	
103-10210-241	Straight	24 cm 9.5"		●	●	●
103-10212-201	Curved	20 cm 8"		●	●	●
103-10212-241	Curved	24 cm 9.5"		●	●	●
103-10212-301	Curved	30 cm 12"	NEW	●		



### Rochester-Ochsner STILLE peang | Rochester-Ochsner STILLE Artery Forceps

Sturdy hemostat with 1x2 teeth. Used when a strong and long forceps is needed, both to occlude blood vessels and to lift or retract organs.

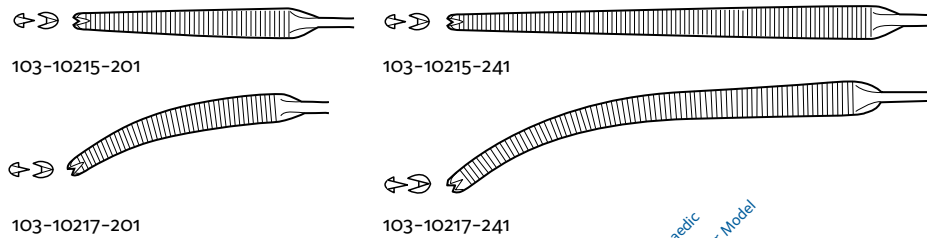

103-10215-201	1x2 teeth	Straight	20 cm 8"	●	●	●
103-10215-241	1x2 teeth	Straight	24 cm 9.5"	●	●	
103-10217-201	1x2 teeth	Curved	20 cm 8"	●	●	
103-10217-241	1x2 teeth	Curved	24 cm 9.5"	●	●	

Plastic  
Orthopaedic  
Popular Model



### Bengolea STILLE peang | Bengolea STILLE Artery Forceps

A long hemostat with straight or curved jaws without teeth.

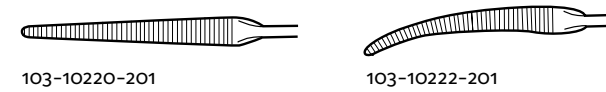

103-10220-201	Straight	20 cm 8"	●	●	
103-10222-201	Curved	20 cm 8"	●	●	●

Plastic  
Orthopaedic  
Popular Model





### Olivecrona STILLE peang | Olivecrona STILLE Artery Forceps

16 cm straight hemostat. Useful as a long hemostat with fine points.



103-10240-161

103-10240-161	Straight	16 cm 6.25"	●	●
---------------	----------	-------------	---	---

Plastic  
Orthopaedic  
Popular Model



### Adson STILLE peang | Adson STILLE Artery Forceps

Popular model when a little longer and fairly delicate hemostat is needed.

103-10260-191	Straight	19 cm 7.5"	NEW	●	●
103-10262-191	Curved	19 cm 7.5"	NEW	●	●

Plastic  
Orthopaedic  
Popular Model



### Dandy STILLE peang | Dandy STILLE Artery Forceps

Side curved hemostat without teeth. Often used in neuro surgery.



103-10310

Plastic  
Orthopaedic  
Popular Model

103-10310 14 cm 5.5"



### Schmidt STILLE peang | Schmidt STILLE Artery Forceps

A hemostat popular in general surgery.



103-10411-201

Plastic  
Orthopaedic  
Popular Model

103-10411-201 Curved 20 cm 8"



## Sawtell STILLE peang | Sawtell STILLE Artery Forceps

A hemostat with half-serrated and fairly strongly curved jaws.

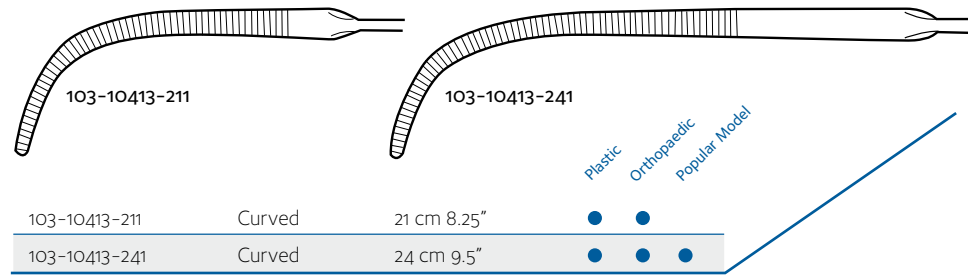

### Heiss STILLE peang | Heiss STILLE Artery Forceps

Dissecting and ligature clamps with half-serrated, jaws.

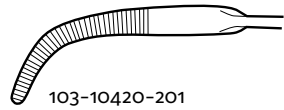

103-10420-201

				Plastic	Orthopaedic	Popular Model
103-10421-211	Straight	21 cm 8.25"	NEW	●	●	
103-10422-211	Curved	21 cm 8.25"	NEW	●	●	
103-10420-201	Strongly curved	20 cm 8"		●	●	●



### Overholt STILLE peang | Overholt STILLE Dissecting Forceps

Strongly curved dissecting forceps.

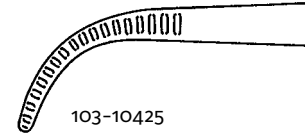

103-10425

			Plastic	Orthopaedic	Popular Model
103-10425	Strongly curved	14 cm 5.5"	●		



## Crafoord STILLE peang | Crafoord STILLE Artery Forceps

Designed for thoracic and cardiovascular surgery. The fine tips make this a very useful instrument. Offers the surgeon Mosquito type tips, but with a length that allows working in a deep cavity.

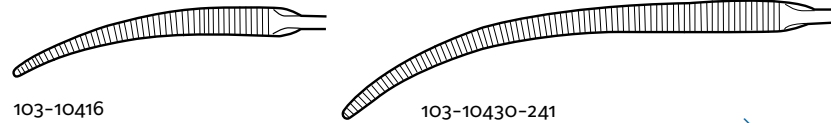

103-10416

103-10430-241

Plastic  
Orthopaedic  
Popular Model

103-10416	Curved	18 cm 7"	●
103-10430-241	Curved	24 cm 9.5"	●



### STILLE artär- och ligaturklämmare | STILLE Artery and Ligature Clamp

Four very delicate models of dissecting forceps with different jaw curvature.

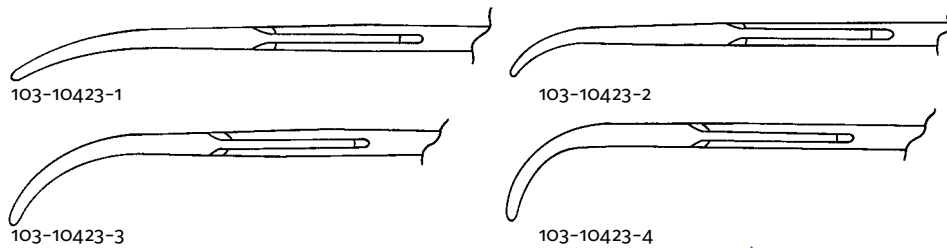

103-10423-1	Slightly curved	20 cm 8"	●	
103-10423-2	Curved	20 cm 8"	●	
103-10423-3	Strongly curved	19,5 cm 7.75"	●	
103-10423-4	Angled 90°	19 cm 7,5"	●	●

Plastic  
 Orthopaedic  
 Popular Model



### STILLE-Ehrén ligaturklämmare | STILLE-Ehrén Ligature Clamp

For fine and precise handling of ligatures in very narrow areas, such as paediatric surgery. The jaws close only at the tips to minimize the risk for accidental clamping of fragile vessels etc. Developed together with Henrik Ehrén, M.D. at Karolinska University Hospital. Matted finish.

103-10428-151 Delicate Strongly curved 15 cm 6" **NEW**

Plastic  
 Orthopaedic  
 Popular Model







**FÖR ETT FULLGOTT RESULTAT VID SUTURERING** krävs ett pålitligt och tåligt instrument. STILLES nålförare känns lätt igen på den gracila och mjuka designen vilket hjälper kirurgen att hålla nålen i ett mycket säkert grepp. De gyllene fingeröglorna indikerar att käftarna är försedda med inlägg av hårdmetall vilket förlänger hållbarheten. Vissa nålförare är istället belagda med Diamond Jaws där hårdmetallen har sprutats på som ett tunt skikt på insidan av käftarna.

Ett annat säkert kännetecken för STILLES nålförare är det öppna boxlåset vilket minskar risken för att nålföraren ska fastna i suturen eller kirurgens handskar. Samtidigt förenklas rengöring och sterilisering. Knäppets unika utformning ser till att nålföraren hålls stängd i ett säkert läge samtidigt som den är enkel att öppna igen. Alla dessa egenskaper ligger bakom den där speciella känslan som instrument från STILLE ger.

För exakt matchning av suturer och nålförare, se separat guide för passande suturstorlek till varje nålförare.



**A PERFECT RESULT WHEN SUTURING** requires a reliable and durable instrument. STILLE needle holders are easily recognized by their delicate and soft design, which helps the surgeon to hold the needle very securely. The golden finger loops indicate that the jaws are fitted with inserts of hard metal, which prolongs the life of the instrument. Some needle holders are instead coated with Diamond Jaws where hard metal is sprayed on as a thin layer on the inside of the jaws.

Another feature of STILLE's needle holders is the open box lock. This reduces the risk of the needle holder being caught in the sutures or the surgeon's gloves. It also simplifies the cleaning and sterilization process. The ratchet's unique design ensures that the instrument stays closed in a safe position while remaining easy to open. All of these features are characteristic of that special feel that instruments from STILLE provide.

For precise matching of sutures and needle holders, see the separate guide for matching suture size to individual needle holders.



# Nålförare | Needle holders | Nadelhalter | Portaghi | Porta-agujas | 持針器

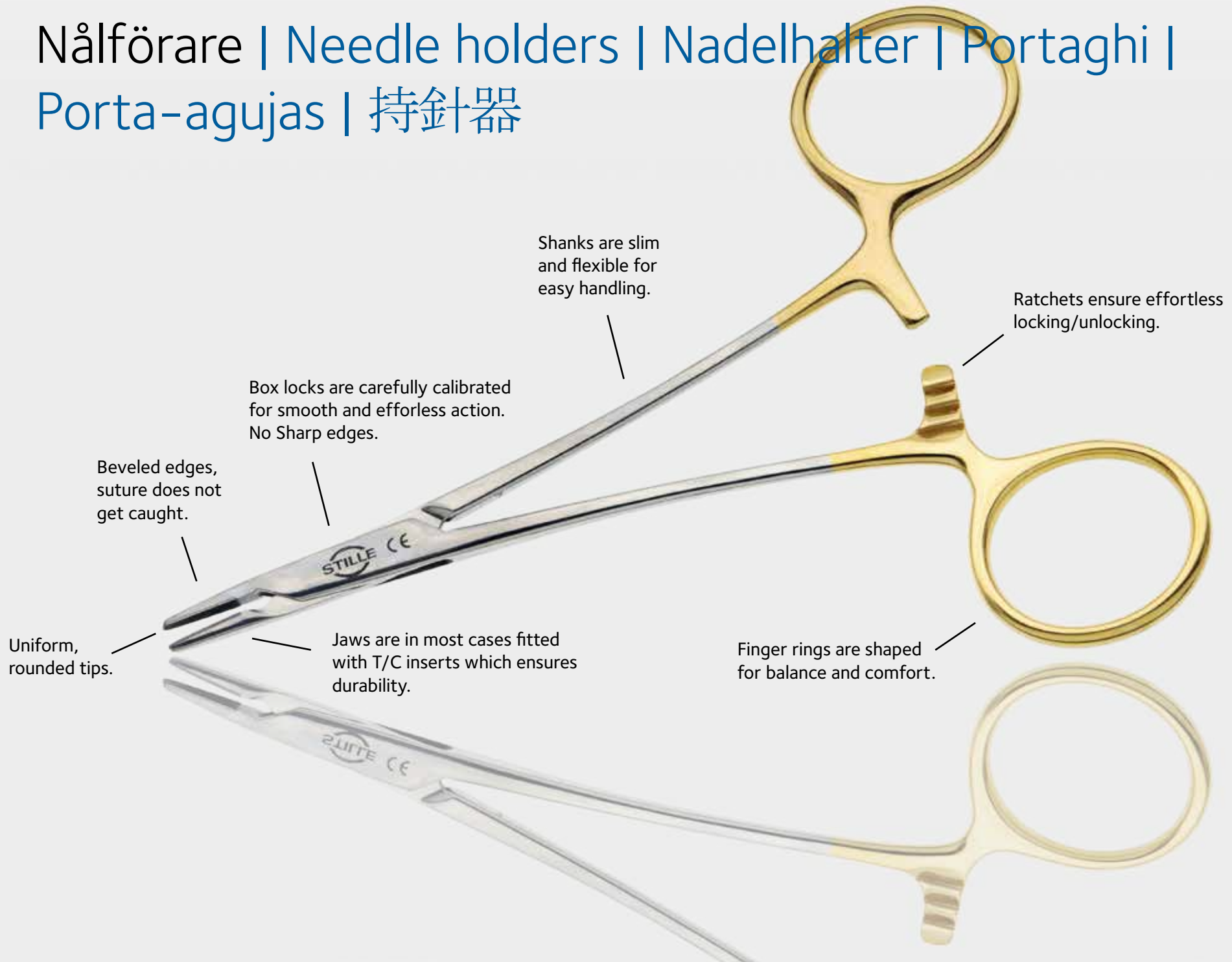



Art.no	Description	Max suture size
104-15542	RAPP-STILLE KNOT-HOLDING FORCEPS 13 cm 5"	3/0
104-15545	WEBSTER STILLE very delicate DD jaws 12 cm 4.75"	5/0
104-15546	WEBSTER STILLE very delicate smooth 12 cm 4.75"	5/0
104-15549-131	KILNER STILLE TC jaws 13 cm 5"	4/0
104-15550	GILLIES STILLE serrated 16 cm 6.25"	2/0
104-15551	GILLIES STILLE TC jaws 16 cm 6.25"	2/0
104-15556	WEBSTER STILLE delicate smooth 12 cm 4.75"	4/0
104-15557	WEBSTER-KLEINERT STILLE smooth offset bows 12 cm 4.75"	4/0
104-15558	WEBSTER STILLE smooth TC jaws 12 cm 4.75"	3/0
104-15559	WEBSTER STILLE serrated TC jaws 12 cm 4.75"	4/0
104-15560	HALSEY STILLE TC jaws 12.5 cm 5"	3/0
104-15560-2	HALSEY STILLE ERGONOMIC TC jaws 12.5 cm 5"	3/0
104-15561-141	MAYO-HEGAR STILLE TC jaws 14 cm 5.5"	0
104-15561-161	MAYO-HEGAR STILLE TC jaws 16 cm 6.25"	0
104-15561-181	MAYO-HEGAR STILLE TC jaws 18 cm 7"	0
104-15561-201	MAYO-HEGAR STILLE TC jaws 20 cm 8"	0
104-15561-251	MAYO-HEGAR STILLE TC jaws 25 cm 10"	0
104-15562-161	MAYO-HEGAR STILLE Heavy Pattern TC jaws 16 cm 6.25"	1
104-15562-181	MAYO-HEGAR STILLE Heavy Pattern TC jaws 18 cm 7"	1
104-15562-201	MAYO-HEGAR STILLE Heavy Pattern TC jaws 20 cm 8"	1
104-15562-241	MAYO-HEGAR STILLE Heavy Pattern TC jaws 24 cm 9.5"	1
104-15562-271	MAYO-HEGAR STILLE Heavy Pattern TC jaws 27 cm 10.5"	1
104-15562-301	MAYO-HEGAR STILLE Heavy Pattern TC jaws 30 cm 12"	1
104-15565-151	CRILE-WOOD STILLE TC jaws 15 cm 6"	2/0
104-15565-181	CRILE-WOOD STILLE TC jaws 18 cm 7"	2/0
104-15565-201	CRILE-WOOD STILLE TC jaws 20 cm 8"	2/0
104-15565-231	CRILE-WOOD STILLE TC jaws 23 cm 9"	2/0

Art.no	Description	Max suture size
104-15566-151	BABY CRILE-WOOD STILLE delicate TC 15 cm 6"	3/0
104-15566-181	CRILE-WOOD STILLE delicate TC jaws 18 cm 7"	3/0
104-15566-201	CRILE-WOOD STILLE delicate TC jaws 20 cm 8"	3/0
104-15566-231	CRILE-WOOD STILLE delicate TC jaws 23 cm 9"	3/0
104-15571	NEW ORLEANS STILLE TC jaws 18 cm 7"	3/0
104-15573-161	RYDER STILLE TC jaws 16 cm 6.25"	3/0
104-15573-181	RYDER STILLE TC jaws 18 cm 7"	3/0
104-15573-201	RYDER STILLE TC jaws 20 cm 8"	3/0
104-15585-161	STILLE DD jaws 16 cm 6.25"	4/0
104-15585-181	STILLE DD jaws 18.5 cm 7.5"	4/0
104-15585-221	STILLE DD jaws 22 cm 8.75"	4/0
104-15585-251	STILLE DD jaws 25 cm 10"	4/0
104-15586	STILLE TC jaws 18 cm 7"	4/0
104-15590-121	OLSEN-HEGAR STILLE TC jaws with scissors 12 cm 4.75"	0
104-15590-131	OLSEN-HEGAR STILLE TC jaws with scissors 13.5 cm 5.25"	0
104-15590-171	OLSEN-HEGAR STILLE TC jaws with scissors 17 cm 6.75"	0
104-15590-181	OLSEN-HEGAR STILLE TC jaws with scissors 18.5 cm 7.25"	0
104-15621-179	MATHIEU STILLE TC jaws 17 cm 6.75"	1
104-15621-209	MATHIEU STILLE TC jaws 18.5 cm 7.25"	1
104-15777	KAYE STILLE with scissors serrated TC jaws 12 cm 4.75"	5/0
104-15785	CONVERSE STILLE TC jaws 10.5 cm 4.25"	4/0

Suture size indicates the largest recommended for each needle holder.

### Derf STILLE nålförare | Derf STILLE Needle holder

Needle holder with rather short TC jaws, popular in plastic surgery. Intended for 3/0 suture and finer.



104-15542

104-15542	TC jaws	12 cm 4.75"	●	●
-----------	---------	-------------	---	---

Plastic  
Orthopaedic  
Popular Model



### Webster STILLE nålförare | Webster STILLE Needle holder

Very delicate needle holder for very fine sutures. Smooth jaws or DD jaws. Intended for 5/0 suture and finer.



104-15545



104-15546

104-15545	Very delicate	DD jaws	12 cm 4.75"	●
104-15546	Very delicate	Smooth	12 cm 4.75"	●

Plastic  
Orthopaedic  
Popular Model

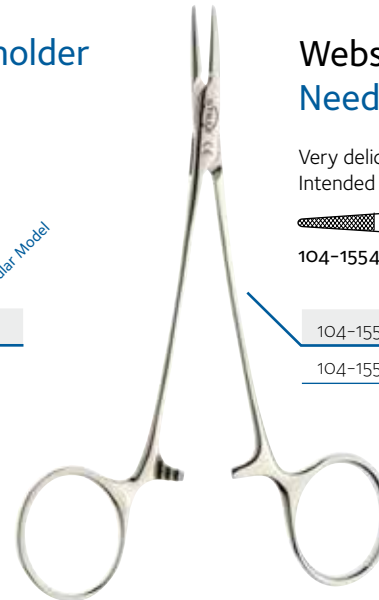

### Kilner STILLE nålförare | Kilner STILLE Needle holder

Delicate needleholder with bayonet shaped shanks. TC jaws. Intended for 4/0 suture and finer.

104-15549-131	13 cm 5"	<b>NEW</b>	●
---------------	----------	------------	---

Plastic  
Orthopaedic  
Popular Model



### Gillies STILLE nålförare | Gillies STILLE Needle Holder

Needle holder with scissors. Ergonomic design on shanks and finger rings. One rather large ring handle is set at an angle for fitting the top of the thumb. Without ratchets. With or without TC jaws. The scissor part enables suturing and cutting with one instrument. Intended for 2/0 suture and finer.

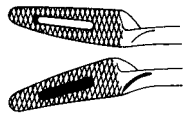

104-15550

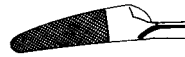

104-15551

Plastic  
Orthopaedic  
Popular Model

104-15550	With scissors		16 cm 6.25"	●
104-15551	With scissors	TC jaws	16 cm 6.25"	●



### Webster/Kleinert STILLE nålförare | Webster/Kleinert STILLE Needle holder

Delicate needle holder for fine needles. With smooth jaws or TC jaws. The Webster-Kleinert (104-15557) has offset bows for a comfortable grip. Intended for 4/0 suture and finer.

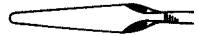

104-15556

104-15557



104-15559

Plastic  
Orthopaedic  
Popular Model

104-15556	Delicate	Smooth	12 cm 4.75"	●
104-15557	Offset bows	Smooth	12 cm 4.75"	●
104-15559	Serrated	TC jaws	12 cm 4.75"	●



### Webster STILLE nålförare | Webster STILLE Needle holder

Delicate needle holder for fine needles. With smooth TC jaws. Intended for 3/0 suture and finer.



104-15558

Plastic  
Orthopaedic  
Popular Model

104-15558	Smooth	TC jaws	12 cm 4.75"	●
-----------	--------	---------	-------------	---





### Halsey STILLE nålförare | Halsey STILLE Needle Holder

Needle holder with TC jaws used in many procedures. One model with ergonomically designed finger ring for thumb. For slightly larger needles than the Webster needle holder. Intended for 3/0 suture and finer.



104-15560

			Plastic	Orthopaedic	Popular Model
104-15560	TC jaws	12.5 cm 5"	●	●	●
104-15560-2 Ergonomic	TC jaws	12.5 cm 5"	●	●	

### Mayo-Hegar STILLE nålförare | Mayo-Hegar STILLE Needle holder

Commonly used general purpose needle holder with TC jaws. Intended for o suture and finer.



104-15561

			Plastic	Orthopaedic	Popular Model
104-15561-141	TC jaws	14 cm 5.5"	●	●	●
104-15561-161	TC jaws	16 cm 6.25"	●	●	●
104-15561-181	TC jaws	18 cm 7"	●	●	●
104-15561-201	TC jaws	20 cm 8"	●	●	●
104-15561-251	TC jaws	25 cm 10"	●	●	●



### Mayo-Hegar STILLE kraftig nålförare | Mayo-Hegar STILLE Heavy Needle holder

Heavier version of the widely used Mayo-Hegar needle holder, with TC jaws. Intended for 1 suture and finer.

					Plastic	Orthopaedic	Popular Model
104-15562-161	Heavy Pattern	TC jaws	16 cm 6.25"	<b>NEW</b>	●	●	
104-15562-181	Heavy Pattern	TC jaws	18.5 cm 7.25"	<b>NEW</b>	●	●	
104-15562-201	Heavy Pattern	TC jaws	20.5 cm 8"	<b>NEW</b>	●	●	
104-15562-241	Heavy Pattern	TC jaws	24 cm 9.5"	<b>NEW</b>	●	●	
104-15562-271	Heavy Pattern	TC jaws	27 cm 10.75"	<b>NEW</b>	●	●	
104-15562-301	Heavy Pattern	TC jaws	30.5 cm 12"	<b>NEW</b>		●	

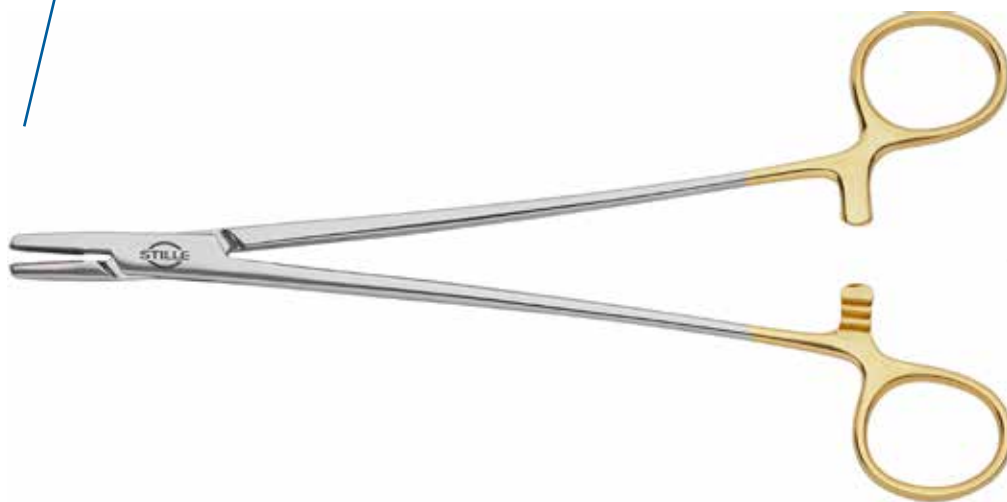

### STILLE Crile-Wood nålförare | STILLE Crile-Wood Needle holder

General purpose needle holder with TC jaws. Intended for 2/0 suture and finer.



104-15565

			Plastic	Orthopaedic	Popular Model
104-15565-151		TC jaws 15 cm 6 in	●	●	
104-15565-181		TC jaws 18 cm 7 in	●	●	
104-15565-201		TC jaws 20 cm 8 in	●	●	
104-15565-231		TC jaws 23 cm 9 in	●	●	

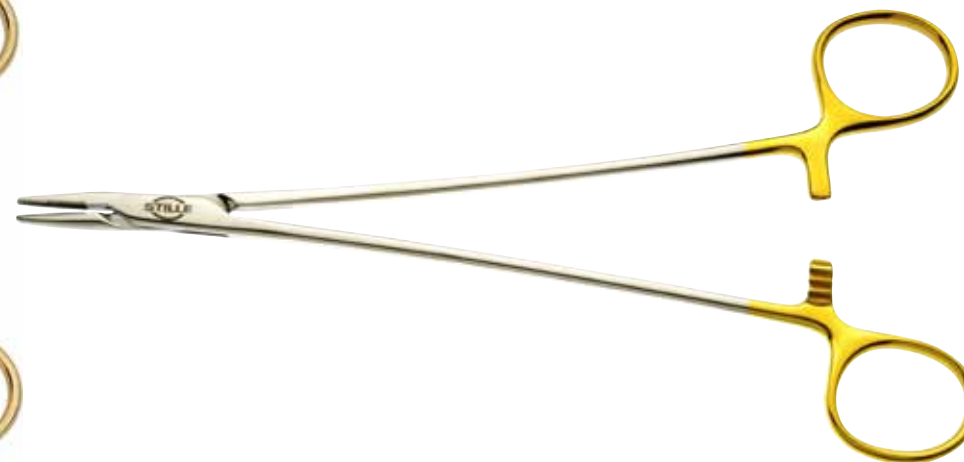

### Crile-Wood STILLE gracil nålförare | Crile-Wood STILLE Delicate Needle holder

Delicate version of the popular Crile-Wood needle holder. With TC jaws. Intended for 3/0 suture and finer.



104-15566

					Plastic	Orthopaedic	Popular Model
104-15566-151	Delicate	TC jaws	15 cm 6"	●	●	●	
104-15566-181	Delicate	TC jaws	18 cm 7"	●	●	●	
104-15566-201	Delicate	TC jaws	20 cm 8"	●	●		
104-15566-231	Delicate	TC jaws	23 cm 9"	●	●		



### New Orleans STILLE nålförare | New Orleans STILLE Needle holder

Short tapered TC jaws, one jaw straight serrated and the other cross-serrated. Intended for 3/0 suture and finer.



104-15571

				Plastic	Orthopaedic	Popular Model
104-15571		TC jaws	18 cm 7"	●	●	

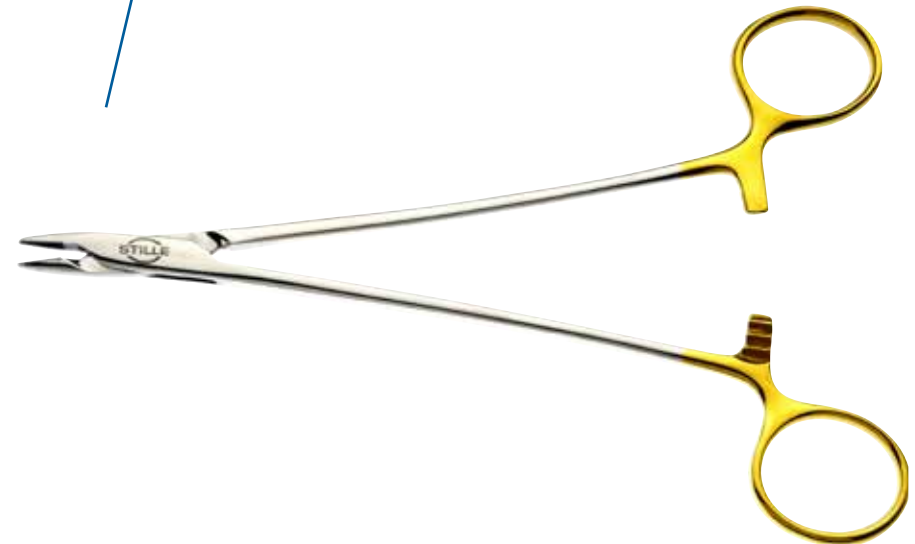

### Ryder STILLE nålförare | Ryder STILLE Needle holder

Needle holder with very narrow, non-tapered, serrated TC jaws. Popular in vascular surgery. Intended for 3/0 suture and finer.



104-15573

			Plastic	Orthopaedic	Popular Model
104-15573-161	TC jaws	16 cm 6.25"	●	●	
104-15573-181	TC jaws	18 cm 7"	●		
104-15573-201	TC jaws	20 cm 8"	●		



### STILLE nålförare | STILLE Needle holder

TC-sprayed delicate jaws. Intended for 4/0 suture and finer.



104-15585

			Plastic	Orthopaedic	Popular Model
104-15585-161	DD jaws	16 cm 6.25"	●		
104-15585-181	DD jaws	18.5 cm 7.5"	●		
104-15585-221	DD jaws	22 cm 8.75"	●		
104-15585-251	DD jaws	25 cm 10"	●		

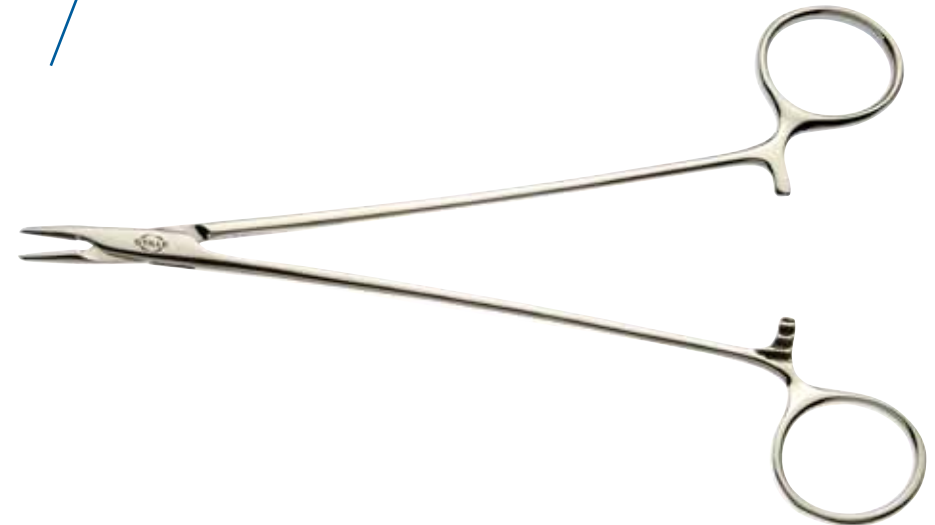



STILLE nålförare | STILLE Needle holder

Delicate needle holder with TC jaws. Intended for 4/0 suture and finer.



104-15586

104-15586	TC jaws	18 cm 7"	Plastic Orthopaedic Popular Model
-----------	---------	----------	---



Olsen-Hegar STILLE nålförare | Olsen-Hegar STILLE Needle holder

Popular needle holder with scissors for suturing and cutting with the same instrument. Intended for 0 suture and finer.

104-15590-121	Scissors	12 cm 4.75"	NEW	Plastic Orthopaedic Popular Model
104-15590-131	Scissors	13.5 cm 5.25"	NEW	Plastic Orthopaedic Popular Model
104-15590-171	Scissors	17 cm 6.75"	NEW	Plastic Orthopaedic Popular Model
104-15590-181	Scissors	18.5 cm 7.25"	NEW	Plastic Orthopaedic Popular Model



### Mathieu STILLE nålförare | Mathieu STILLE Needle holder

Needle holder with straight TC jaws. Plier type handle with ratchets that allows the surgeon to open and close the needle holder rapidly. Intended for 1 suture and finer.



104-15621

Plastic  
Orthopaedic  
Popular Model

104-15621-179	TC jaws	17 cm 6.75"	●
104-15621-209	TC jaws	18.5 cm 7.25"	●



### Kaye STILLE nålförare | Kaye STILLE Needle holder

Delicate needle holder with short, fine TC jaws and sharp scissors. The scissor part enables suturing and cutting with one instrument. Intended for 5/0 suture and finer.



104-15777

Plastic  
Orthopaedic  
Popular Model

104-15777	Serrated	TC jaws	12 cm 4.75"	●
-----------	----------	---------	-------------	---



## Converse STILLE nålförare | Converse STILLE Needle holder

Short and delicate needle holder for fine work. With TC jaws. Intended for 4/0 suture and finer.

104-15785	TC jaws	10.5 cm 4.75"	<b>NEW</b>	●
-----------	---------	---------------	------------	---

Plastic  
Orthopaedic  
Popular Model



## Rapp-STILLE knuthållartång | Rapp-STILLE Knot-holding Forceps

A 13 cm knot-holding forceps with smooth jaws. Ideal instrument to use as a tool for holding the suture knot in narrow areas.



104-15140

104-15140 13 cm 5"

Plastic  
Orthopaedic  
Popular Model



### STILLE ståltrådsroterare | STILLE Wire Twisting Forceps

A good tool for twisting steel wires. With TC jaws.

				Plastic	Orthopaedic	Popular Model
104-15832	TC-inserts	15 cm 6"	<b>NEW</b>		●	
104-15835	TC-inserts	18,5 cm 7.25"	<b>NEW</b>		●	

### STILLE ståltrådshållare | STILLE Wire Holding Forceps

For holding steel wires. Equipped with double-action joint and TC jaws. The jaws close parallel to secure a firm grip of the wire.

				Plastic	Orthopaedic	Popular Model
104-15854	Fine	18 cm 7"	<b>NEW</b>		●	
104-15855	Medium	18 cm 7"	<b>NEW</b>		●	
104-15856	Large	18 cm 7"	<b>NEW</b>		●	

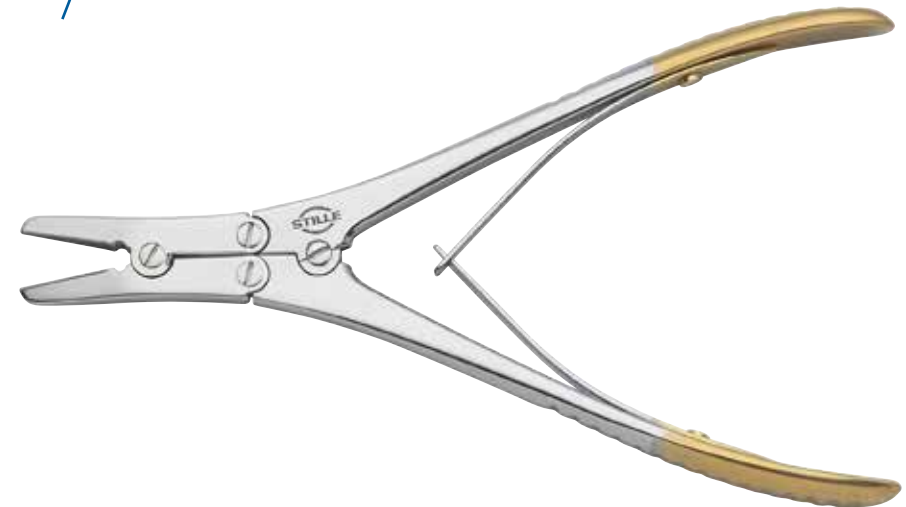

Regarding new products, please see [www.stille.se](http://www.stille.se) for latest update. Product images to be added in next printed edition.



**THESE DOUBLE-ACTION BONE RONGEURS** allow the surgeon to gently and smoothly cut bone with one hand. STILLE invented this double-action solution as early as 1872 and since then, both our bone cutters and rongeurs have been widely imitated. But the original is always better than the imitation, and are perceived by many surgeons as more graceful and easier to use than any other brand.

Double-action bone rongeurs increase the force at the cutting surface when cutting bone with maximum leverage. The special design means that they do not obstruct the view of the operative area. They can be used for orthopaedics, neurosurgery and plastic surgery.

STILLE bone rongeurs are not riveted at the joints, but are assembled using precision screws instead. This means that they can be easily taken apart for sharpening and service, which prolongs the life of the instrument considerably. Choosing original STILLE bone rongeurs is a worthwhile investment and offers a unique feel and ultra precision.

**MED DUBBELLEDADE BENTÄNGER** går det att klippa i benvävnad med bara en hand, mjukt och smidigt. STILLE uppfann den dubbelledade lösningen redan 1872 och sedan dess har såväl våra benavbitare som gougetänger ofta kopierats. Men originalet är alltid bättre än kopian och upplevs av många kirurger som gracilare och enklare att använda än alla andra fabrikat.

Dubbelledade bentänger ökar kraften vid skärytan när man klipper i ben vid maximal utväxling. Bentängernas speciella utformning gör att de inte skymmer sikten i arbetet. De kan användas inom både ortopedi, neurokirurgi och plastikkirurgi.

STILLES bentänger är inte nitade i lederna utan istället monterade med precisionsskruvar. Det gör att de lätt kan tas isär vid slipning och service vilket förlänger instrumentens livslängd avsevärt. Att investera i en original STILLE bentång lönar sig samtidigt som instrumentet erbjuder en unik känsla och precision.



Bentänger | Bone cutters and rongeurs | Knochen & hohlmeisselzangen | Cesioie per ossa & pinze sgorbie | Pinzas cortantes & pinzas-gubias | 骨剪刀および骨鉗子(ロンジュール)

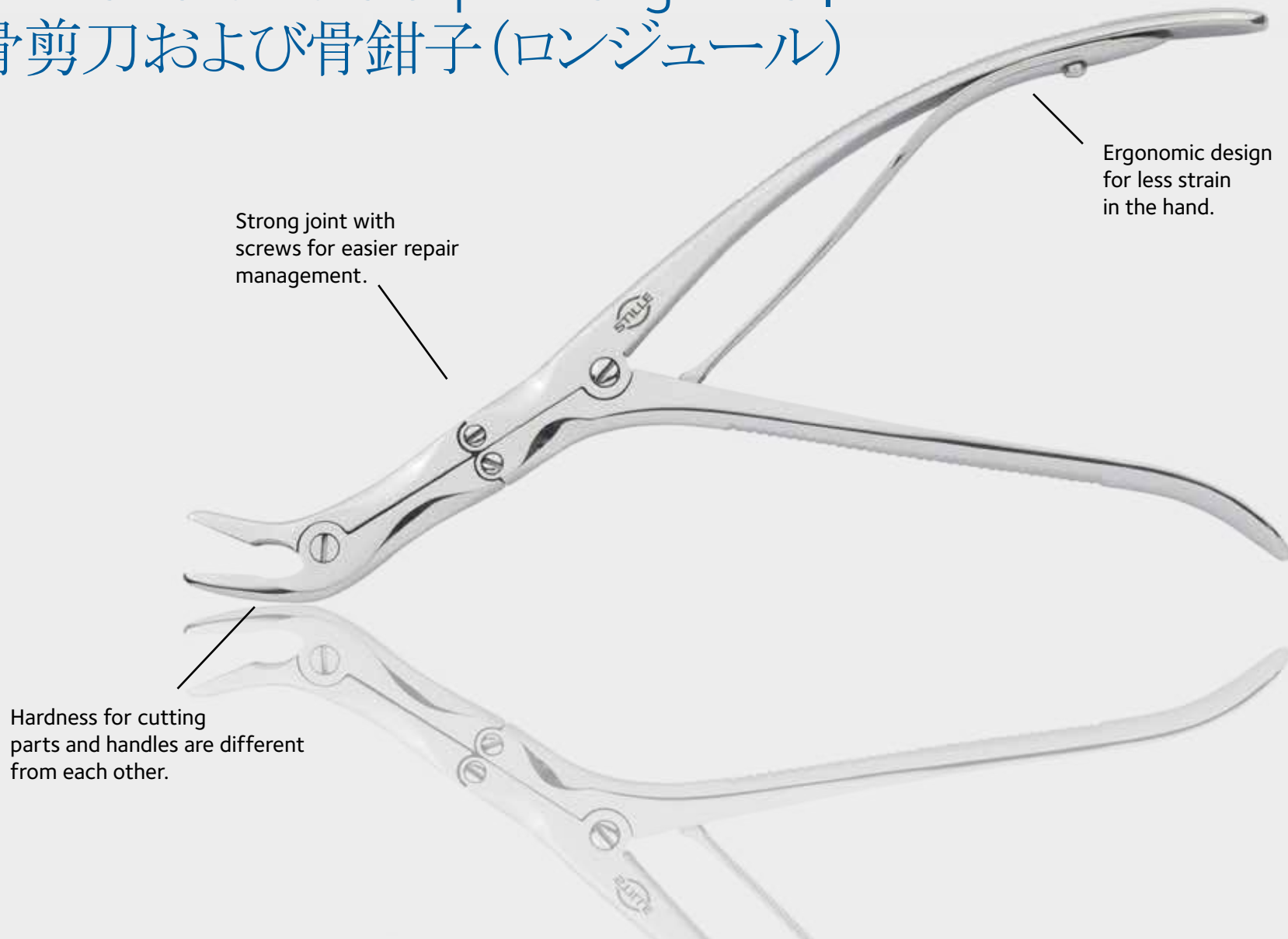

### STILLE plattång | STILLE Flat pliers

General purpose flat pliers with cross-serrated jaws.

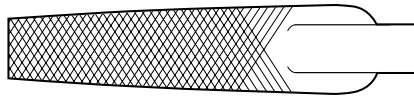

105-16015

Plastic  
Orthopaedic  
Popular Model

105-16015 Cross-serrated 17 cm 6.75"





## STILLE extraktionstång | STILLE Extraction plier

Original STILLE double-action joint facilitates removal of pins and wires.



105-16020



105-16020-1

			Plastic	Orthopaedic	Popular Model
105-16020		19 cm 7.5"	●		
105-16020-1	Narrow jaws	19 cm 7.5"		●	



### STILLE benavbitare | STILLE Bone Cutting Forceps

Bone cutting forceps with original STILLE double-action joint.



### STILLE benavbitare | STILLE Bone Cutting Forceps

Delicate bone cutting forceps with original STILLE double-action joint.

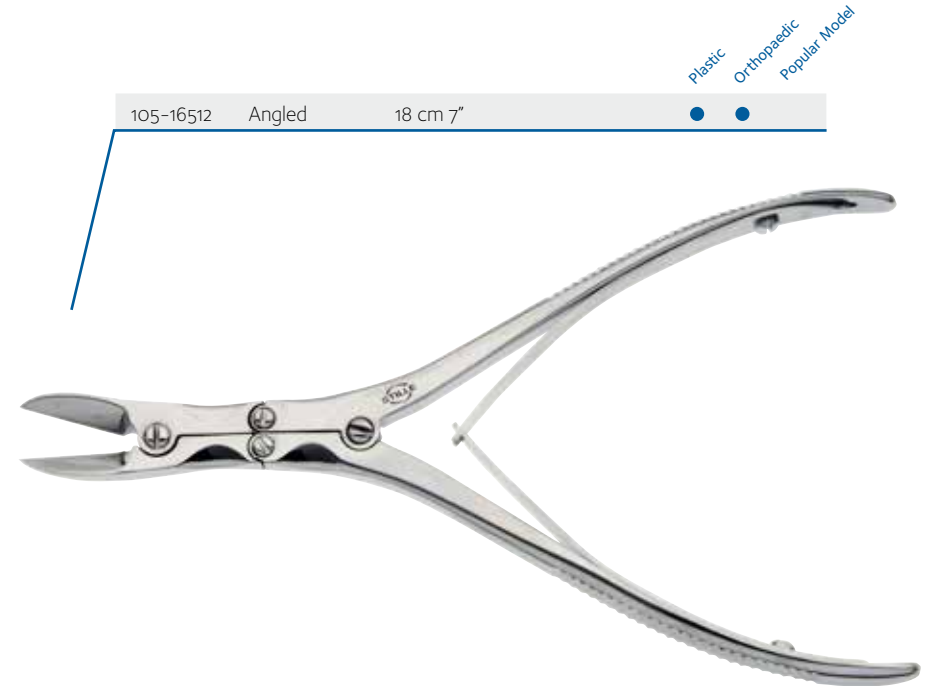

## STILLE benavbitare | STILLE Bone Cutting Forceps

Original STILLE double-action angled bone cutting forceps.

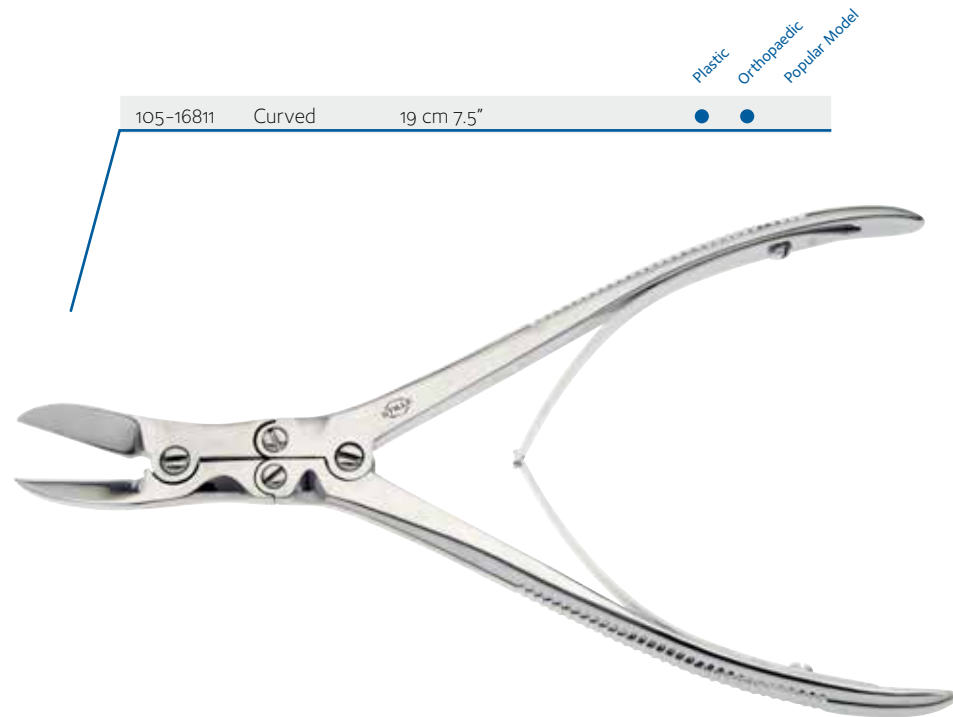

### Beyer STILLE gougetång | Beyer STILLE Bone Rongeur

Nasal rongeur with curved, delicate jaws.

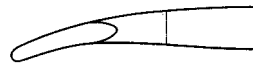

105-17030

105-17030 Curved 17 cm 6.75"

Plastic  
Orthopaedic  
Popular Model



### Håkansson STILLE gougetång | Håkansson STILLE Bone Rongeur

Bone rongeur with curved jaws.

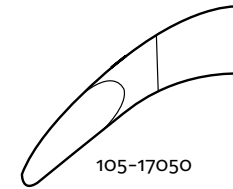

105-17050

105-17050-1 Curved 19 cm 7.5"

Plastic  
Orthopaedic  
Popular Model



### Beyer STILLE gougetång | Beyer STILLE Bone Rongeur

Bone rongeur with original STILLE double-action joint and two different jaw widths.



105-17210



105-17211

				Plastic	Orthopaedic	Popular Model
105-17210	Curved		18 cm 7"	●	●	●
105-17211	Curved	Delicate	18 cm 7"	●	●	●



### Zaufal-Jansen STILLE gougetång | Zaufal-Jansen STILLE Bone Rongeur

Bone rongeur with original STILLE double-action joint and wide, curved jaws.



105-17215

				Plastic	Orthopaedic	Popular Model
105-17215	Curved		17 cm 6.75"	●	●	●



### STILLE gougetång | STILLE Bone Rongeur

Bone rongeurs with STILLE double-action joint and two different jaw widths.



105-17216



105-17217

				Plastic	Orthopaedic	Popular Model
105-17216	Curved	15 cm 6"		●		
105-17217	Delicate jaws	Curved	15 cm 6"		●	



### Ruskin-STILLE gougetång | Ruskin-STILLE Bone Rongeur

Bone rongeur with original STILLE double-action joint and curved jaws.



105-17220

			Plastic	Orthopaedic	Popular Model
105-17220	Curved	19 cm 7.5"	●	●	



## Luer-STILLE gougetång | Luer-STILLE Bone Rongeur

Bone rongeur with original STILLE double-action joint and strongly curved wide jaws.

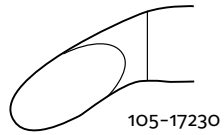

105-17230

105-17230	Curved	22 cm 8.75"	<input checked="" type="radio"/>
-----------	--------	-------------	----------------------------------

Plastic  
Orthopaedic  
Popular Model



### STILLE gougetång | STILLE Bone Rongeur

Bone rongeur with original STILLE double-action joint and sideways curved jaws.

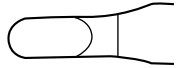

105-17250

105-17250 Curved 22 cm 8.75"

Plastic  
Orthopaedic  
Popular Model





## Leksell STILLE gougetång | Leksell STILLE Bone Rongeur

Bone rongeur with original STILLE double-action joint and sideways slightly curved jaws.



105-17260



105-17261

				Plastic	Orthopaedic	Popular Model
105-17260	Curved	Wide jaws	24 cm 9.5"	●	●	
105-17261	Curved	Narrow jaws	24 cm 9.5"	●	●	



## Leksell STILLE gougetång | Leksell STILLE Bone Rongeur

Bone rongeur with original STILLE double-action joint and sideways strongly curved jaws.

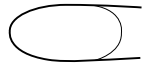

105-17265

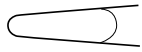

105-17266

105-17265	Curved	Wide jaws	24 cm 9.5"	●
105-17266	Curved	Narrow jaws	24 cm 9.5"	●

Plastic  
Orthopaedic  
Popular Model

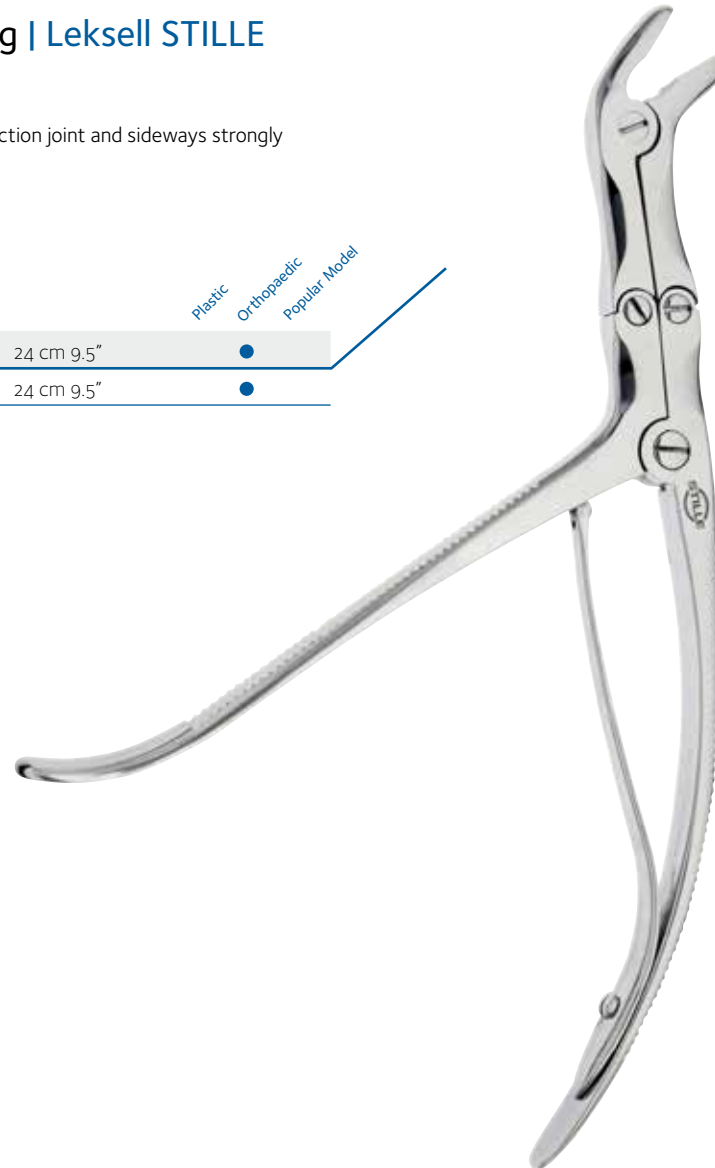

## STILLE gougetång | STILLE Bone Rongeur

Bone rongeur with original STILLE double-action joint and sideways strongly curved jaws in different sizes.

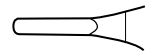

105-17267

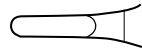

105-17268

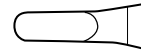

105-17269

105-17267	Curved jaws	2 mm	24 cm 9.5"	●
105-17268	Curved jaws	3 mm	24 cm 9.5"	●
105-17269	Curved jaws	4 mm	24 cm 9.5"	●

Plastic  
Orthopaedic  
Popular Model



**Semb STILLE benhållartång | Semb STILLE Bone Holding Forceps**

Bone holding forceps with or without locking mechanism.

				Plastic Orthopaedic Popular Model
105-16150	19.5 cm 7.75"	<b>NEW</b>	●	
105-16152	With lock 19.5 cm 7.75"	<b>NEW</b>	●	



### STILLE trådavbitare | STILLE Wire Cutter

Single joint wire cutter with TC-inserts. For hard wire up to 0.4 mm and soft wire up to 0.6 mm.

105-16215	TC inserts	12.5 cm 5"	<b>NEW</b>	<input checked="" type="radio"/> Plastic <input type="radio"/> Orthopaedic <input type="radio"/> Popular Model
-----------	------------	------------	------------	--



### STILLE trådavbitare | STILLE Wire Cutter

Double joint wire cutter with TC-inserts. For hard wire up to 1.7 mm and soft wire up to 2.0 mm.

105-16223	TC inserts	17.5 cm 7"	<b>NEW</b>	<input checked="" type="radio"/> Plastic <input type="radio"/> Orthopaedic <input type="radio"/> Popular Model
-----------	------------	------------	------------	--



## STILLE trådavbitare | STILLE Wire Cutter

Strong double joint wire cutter with TC-inserts. For hard wire up to 2.5 mm and soft wire up to 2.8 mm.

105-16225	TC inserts	22 cm 8.75"	<b>NEW</b>	<ul style="list-style-type: none"> <li>Plastic</li> <li>Orthopaedic</li> <li>Popular Model</li> </ul>
-----------	------------	-------------	------------	---

Regarding new products, please see [www.stille.se](http://www.stille.se) for latest update. Product images to be added in next printed edition.

## Kerrison STILLE laminektomistans | Kerrison STILLE Laminectomy Punch

The popular Kerrison punches with a unique rubber coated handle for improved ergonomomy. No spring between the handles improves the accessibility in cleaning and decreases the risk for getting caught with the gloves. All models come with ejector, 130° up cutting and thin footplate.

				Plastic Orthopaedic Popular Model
105-17642-2	18 cm 7"	2 mm	<b>NEW</b>	●
105-17642-3	18 cm 7"	3 mm	<b>NEW</b>	●
105-17642-4	18 cm 7"	4 mm	<b>NEW</b>	●
105-17642-5	18 cm 7"	5 mm	<b>NEW</b>	●
105-17643-2	20 cm 8"	2 mm	<b>NEW</b>	●
105-17643-3	20 cm 8"	3 mm	<b>NEW</b>	●
105-17643-4	20 cm 8"	4 mm	<b>NEW</b>	●
105-17643-5	20 cm 8"	5 mm	<b>NEW</b>	●
105-17644-2	23 cm 9"	2 mm	<b>NEW</b>	●
105-17644-3	23 cm 9"	3 mm	<b>NEW</b>	●
105-17644-4	23 cm 9"	4 mm	<b>NEW</b>	●
105-17644-5	23 cm 9"	5 mm	<b>NEW</b>	●

Regarding new products, please see [www.stille.se](http://www.stille.se) for latest update. Product images to be added in next printed edition.

## Kerrison STILLE laminektomistans | Kerrison STILLE Laminectomy Punch

The same fine Kerrison punches are also available with coating for increased durability.

				Plastic	Orthopaedic	Popular Model
105-17642-2-C	18 cm 7"	2 mm	NEW	●		
105-17642-3-C	18 cm 7"	3 mm	NEW	●		
105-17642-4-C	18 cm 7"	4 mm	NEW	●		
105-17642-5-C	18 cm 7"	5 mm	NEW	●		
105-17643-2-C	20 cm 8"	2 mm	NEW	●		
105-17643-3-C	20 cm 8"	3 mm	NEW	●		
105-17643-4-C	20 cm 8"	4 mm	NEW	●		
105-17643-5-C	20 cm 8"	5 mm	NEW	●		
105-17644-2-C	23 cm 9"	2 mm	NEW	●		
105-17644-3-C	23 cm 9"	3 mm	NEW	●		
105-17644-4-C	23 cm 9"	4 mm	NEW	●		
105-17644-5-C	23 cm 9"	5 mm	NEW	●		





### Cushing STILLE bittång | Cushing STILLE Rongeur

Rongeur for intervertebral discs, with semi-detachable shaft. Available with or without coating. Jaw size 2x10 mm.

					Plastic	Orthopaedic	Popular Model
105-13921-18	2x10 mm	18 cm 7"		<b>NEW</b>	●		
105-13921-18-C	2x10 mm	18 cm 7"	Coated	<b>NEW</b>		●	

### Love-Gruenwald STILLE bittång | Love-Gruenwald STILLE Rongeur

Rongeur for intervertebral discs, with semi-detachable shaft. Available with or without coating. Jaw size 3x10 mm.

					Plastic	Orthopaedic	Popular Model
105-13931-18	3x10 mm	18 cm 7"		<b>NEW</b>	●		
105-13931-18-C	3x10 mm	18 cm 7"	Coated	<b>NEW</b>		●	



Regarding new products, please see [www.stille.se](http://www.stille.se) for latest update. Product images to be added in next printed edition.

## Spurling STILLE bittång | Spurling STILLE Rongeur

Rongeur for intervertebral discs, with semi-detachable shaft. Available with or without coating. Jaw size 4x10 mm.

					Plastic	Orthopaedic	Popular Model
105-13941-18	4x10 mm	18 cm 7"		<b>NEW</b>	●		
105-13941-18-C	4x10 mm	18 cm 7"	Coated	<b>NEW</b>		●	



## Caspar STILLE bittång | Caspar STILLE Rongeur

Rongeur for intervertebral discs, with semi-detachable shaft. Available with or without coating. Fenestrated and serrated jaws in three different sizes.

						Plastic	Orthopaedic	Popular Model
105-13955-18	2x12 mm	18 cm 7"		<b>NEW</b>		●		
105-13955-18-C	2x12 mm	18 cm 7"	Coated	<b>NEW</b>		●		
105-13956-18	3x12 mm	18 cm 7"		<b>NEW</b>		●		
105-13956-18-C	3x12 mm	18 cm 7"	Coated	<b>NEW</b>		●		
105-13957-18	4x14 mm	18 cm 7"		<b>NEW</b>		●		
105-13957-18-C	4x14 mm	18 cm 7"	Coated	<b>NEW</b>		●		





**EN KÄRLKLÄMMA MÅSTE GE EXAKT DET TRYCK** som krävs för att stoppa en blödning på ett säkert men ändå atraumatiskt sätt. Stänger klämman inte korrekt om kärlet riskerar det att skadas.

Den approximala stängningen av käftarna mot den distala delen fördelar käftarnas tryck jämnt över blodkärlet. Därmed blir trycket så litet som möjligt, men ändå effektivt. En klämman måste även tåla den mekaniska spänning den utsätts för.

Ett annat säkert kännetecken för STILLEs kärklämmare är det öppna boxlåset, vilket minskar risken för att instrumentet ska fastna i vävnad eller kirurgens handskar. Samtidigt förenklas rengöring och sterilisering. Knäppets unika utformning ser till att kärklämmaren hålls stängd i ett säkert läge samtidigt som den är enkel att öppna igen. Knäppena på STILLEs kärklämmare är försedda med flera steg för att möjliggöra korrekt tryck över kärlet.

I sortimentet ingår också ett antal andra klämmare med samma unika STILLE-kvalitet, som t ex fattningstänger, dukklämmor och ringtänger.



**A VASCULAR CLAMP MUST PROVIDE THE EXACT PRESSURE** required to stop bleeding in a safe and atraumatic way. If the clamp closes improperly the vessel is likely to be damaged.

The closure of the jaws on the distal portion ensures pressure is evenly distributed over the blood vessel. Thus, the pressure is as small as possible while maintaining effectiveness. A clamp must also withstand the mechanical stress it is subjected to.

Another sure characteristic of STILLE's vascular clamps is the open box lock, which reduces the risk of the instrument getting stuck in the tissue or the surgeon's gloves, while simplifying the cleaning and sterilization process. The ratchet's unique design ensures that the instrument stays closed in a safe position while being easy to open. Closures on STILLE vascular clamps are fitted with several steps to allow various degrees of pressure on the vessel.

The range also includes a number of other clamps with the same unique STILLE quality, such as tissue grasping forceps, towel clamps and ring forceps.

# Klämmare | Clamps | Klemmen | Pinze | Pinzas | 血管鉗子および組織把持鉗子

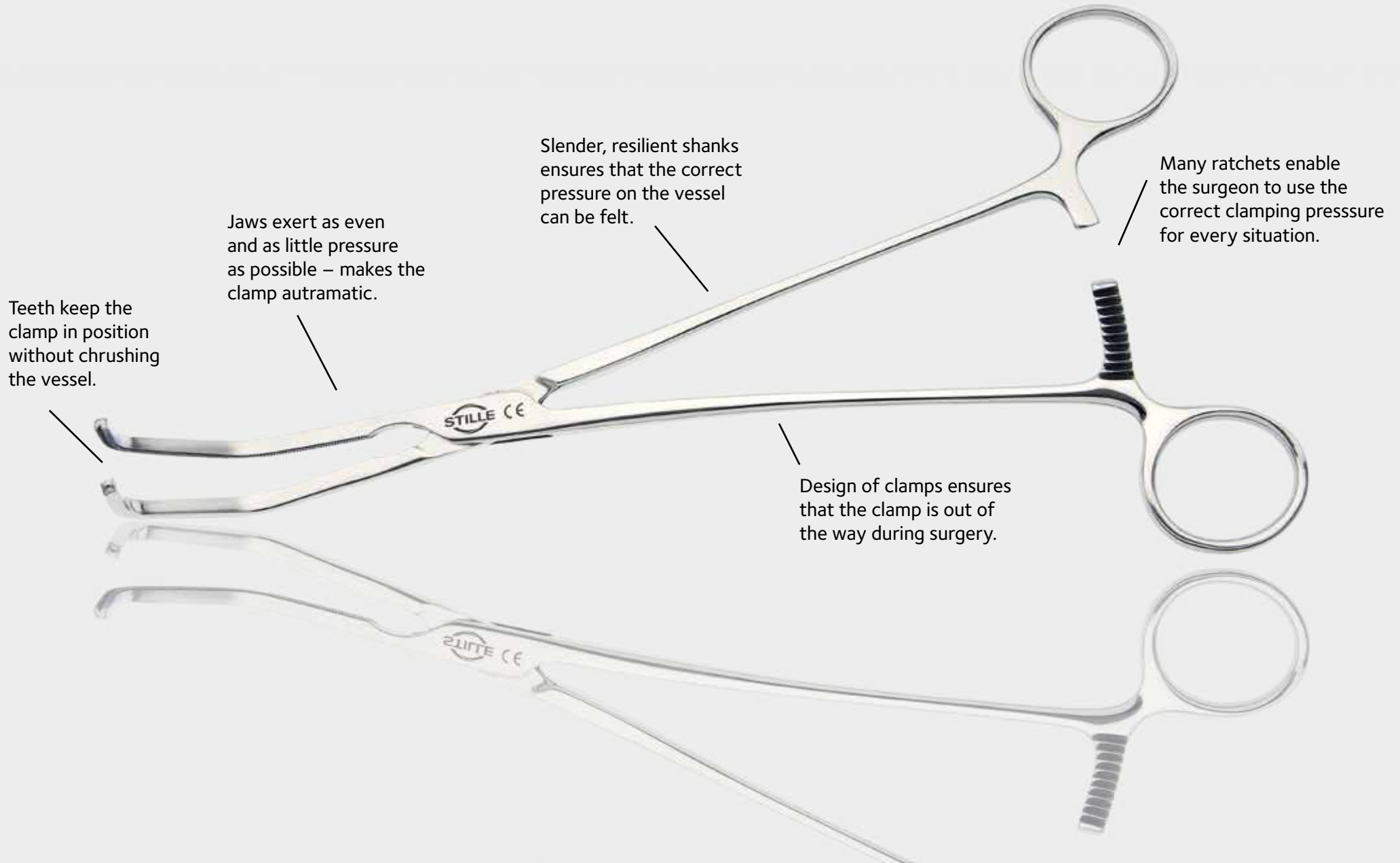

### STILLE colonklämmare | STILLE Colon Clamp

Colon clamp with atraumatic DeBaKey jaws. Long ratchet for precise adjustment.

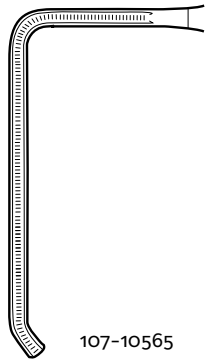

107-10565

107-10565	Atraumatic	5 cm jaws	23.5 cm 9.25"
-----------	------------	-----------	---------------

Plastic  
Orthopaedic  
Popular Model



### Wikström STILLE galltång | Wikström STILLE Gall Duct Clamp

Gall duct clamp with angled, serrated jaws.

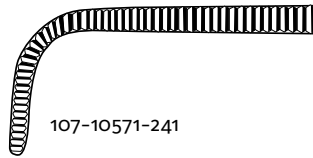

107-10571-241

Plastic  
Orthopaedic  
Popular Model

107-10571-241    Angled    24 cm 9.5"    ●



### Uppsala STILLE galltång | Uppsala STILLE Gall Duct Clamp

Gall duct clamp with S-shaped, serrated jaws.

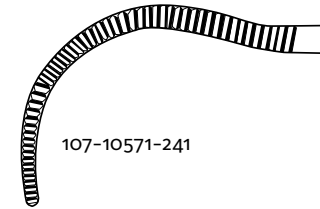

107-10581-241

Plastic  
Orthopaedic  
Popular Model

107-10581-241    S-shaped    24 cm 9.5"    ●



**STILLE mini universalklammare |**  
**STILLE mini Multi-purpose clamp**

Multipurpose vascular mini clamps with spoon shaped atraumatic DeBakey jaws.



107-10655



107-10656

107-10655	Small	20 mm jaws	15.5 cm 6.25"
107-10656	Angled shanks	20 mm jaws	15 cm 6"

Plastic  
Orthopaedic  
Popular Model



**STILLE mini universalklammare |**  
**STILLE mini Multi-purpose clamp**

Multipurpose vascular mini clamps with atraumatic DeBakey jaws.



107-10665



107-10670

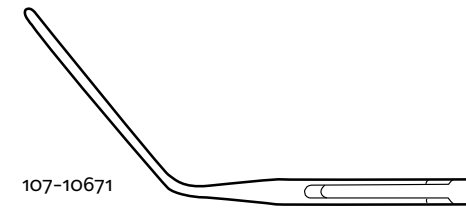

107-10671

107-10665	Straight shanks	25 mm jaws	15.5 cm 6.25"
107-10670	Angled 30°	30 mm jaws	15.5 cm 6.25"
107-10671	Angled 50°	30 mm jaws	15 cm 6"

Plastic  
Orthopaedic  
Popular Model





STILLE universalklammare | STILLE Multi-purpose clamp

Multi purpose clamps with angled, atraumatic DeBakey jaws.

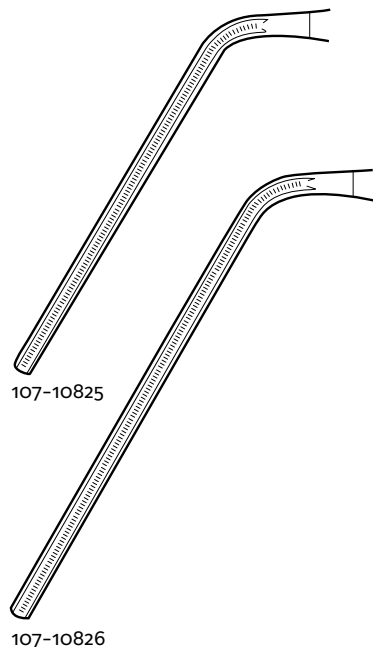

107-10825	Atraumatic	6 cm jaws	23 cm 9"
107-10826	Atraumatic	7.5 cm jaws	22.5 cm 8.75"

Plastic  
Orthopaedic  
Popular Model



**STILLE universalklammare | STILLE  
Multi-purpose clamp**

Multi purpose clamps with angled, atraumatic DeBakey jaws.

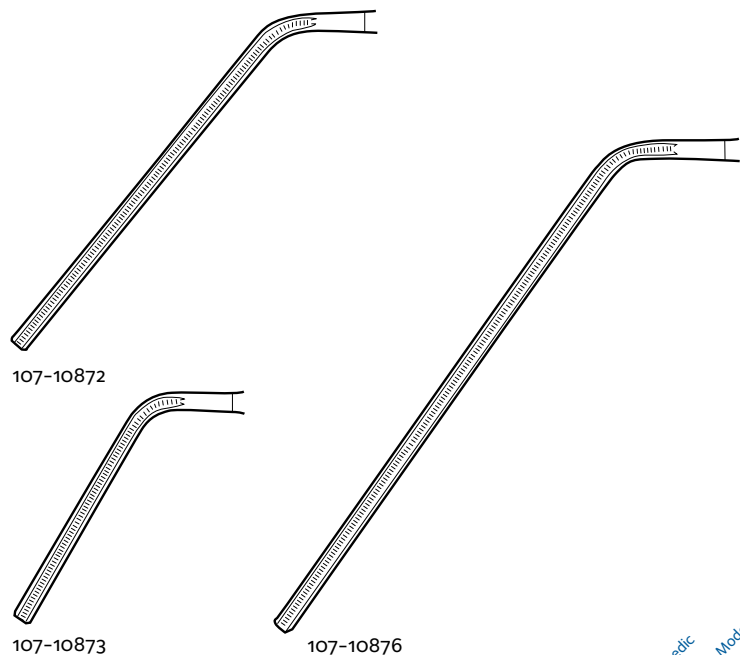

107-10872	Atraumatic	6 cm jaws	18.5 cm 7.25"
107-10873	Atraumatic	3.5 cm jaws	15.5 cm 6.25"
107-10876	Atraumatic	8 cm jaws	20 cm 8"

Plastic  
Orthopaedic  
Popular Model



## STILLE mini tangential occlusionsklämmare | STILLE mini Tangential Occlusion Clamp

Tangential occlusion mini clamps with three different jaw sizes.  
 With atraumatic DeBakey jaws.

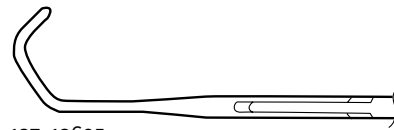

107-10695

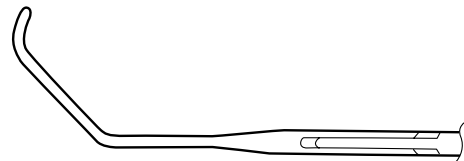

107-10696

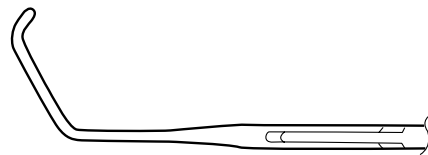

107-10697

107-10695	Small	14 mm jaws	14 cm 5.5"
107-10696	Medium	15 mm jaws	15 cm 6"
107-10697	Large	24 mm jaws	15 cm 6"

Plastic  
 Orthopaedic  
 Popular Model



**Satinsky STILLE tangential occlusionsklämmare**  
**| Satinsky STILLE Tangential Occlusion Clamp**

Tangential occlusion clamps with atraumatic DeBakey jaws.

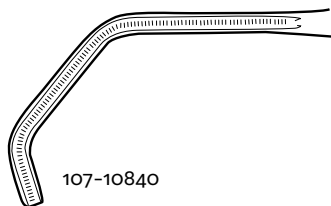

107-10840

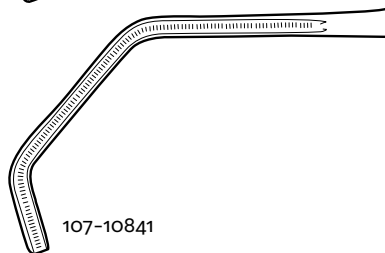

107-10841

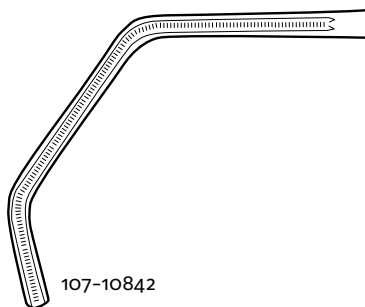

107-10842

107-10840	Atraumatic	Small	22 cm 8.75"
107-10841	Atraumatic	Medium	22.5 cm 9"
107-10842	Atraumatic	Large	23 cm 9"

Plastic  
 Orthopaedic  
 Popular Model



## STILLE perifer kärlklämmare | STILLE Peripheral Vascular Clamp

Peripheral vascular clamp with atraumatic DeBakey jaws.

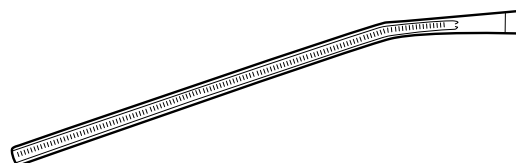

107-10871

Plastic  
Orthopaedic  
Popular Model

107-10871    Atraumatic    6 cm jaws    20 cm 8"

Regarding new products, please see [www.stille.se](http://www.stille.se) for latest update. Product images to be added in next printed edition.

**STILLE anastomosklämmare** | **STILLE Anastomosis Clamp**

Anastomosis clamps with atraumatic DeBakey jaws.

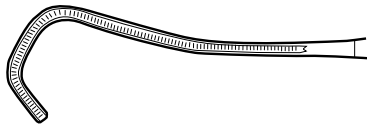

107-10860

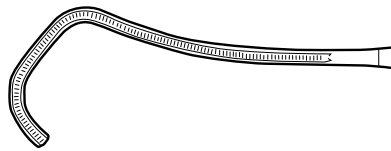

107-10861

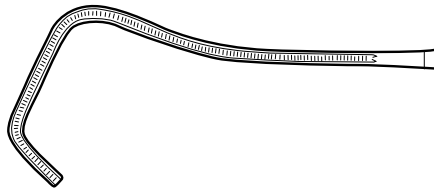

107-10862

107-10860	Atraumatic	1 cm jaws	17,5 cm 7"
107-10861	Atraumatic	1,5 cm jaws	17,5 cm 7"
107-10862	Atraumatic	2 cm jaws	18,5 cm 7.25"

Plastic  
 Orthopaedic  
 Popular Model



**Lambert-Kay STILLE aorta anastomosklämmare |  
Lambert-Kay STILLE Aortic-Anastomosis Clamp**

Aortic anastomosis clamp with atraumatic DeBakey jaws.

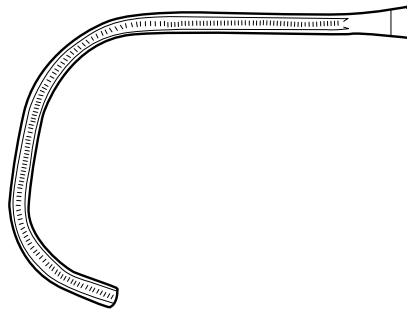

107-10845

107-10845 Atraumatic 22 cm 8.75"

Plastic  
Orthopaedic  
Popular Model



**STILLE DeBakey aorta aneurysmklämmare** |  
**STILLE DeBakey Aortic-Aneurysm Clamp**

Aortic aneurysm clamp with atraumatic DeBakey jaws.

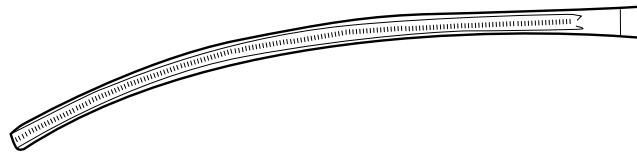

107-10846

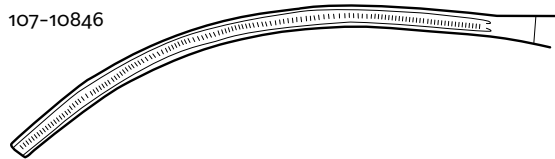

107-10849

Plastic  
 Orthopaedic  
 Popular Model

107-10846	Atraumatic	8 cm jaws	26 cm 10.25"
107-10849	Atraumatic	7 cm jaws	28 cm 11"





### Ericsson-STILLE carotisklämmare | Ericsson-STILLE Carotid Clamp

Carotid clamp with angled atraumatic DeBakey jaws.

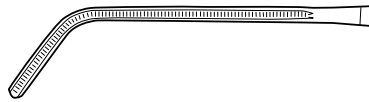

107-10880

107-10880	Atraumatic	17,5 cm 7"
-----------	------------	------------

Plastic  
Orthopaedic  
Popular Model

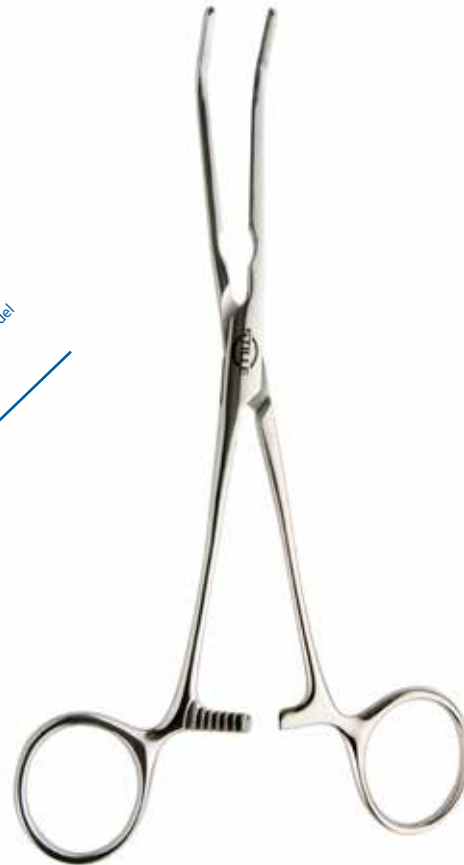

**Ericsson-STILLE profunda arteria femoralis klämmare** | **Ericsson-STILLE Profunda Femoral Artery Clamps**

Profunda femoral artery clamp with atraumatic DeBakey jaws.

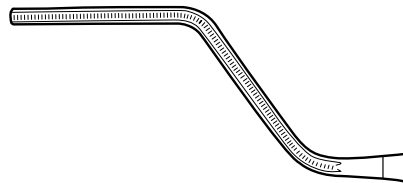

107-10898

107-10898 Atraumatic 18 cm 7"

Plastic  
 Orthopaedic  
 Popular Model



## Backhaus STILLE dukklämmare | Backhaus STILLE Towel Clamps

Towel clamps in two different versions. Sharp/sharp or ball/socket for paper towels.

				Plastic	Orthopaedic	Popular Model
107-10910	Sharp/Sharp	11 cm 4.25"		●	●	●
107-10912	Ball/socket	13.5 cm 5.25"	<b>NEW</b>	●	●	



**Babcock STILLE fattningstång** | Babcock STILLE  
Intestinal Grasping Forceps

Intestinal grasping forceps in two different lengths.

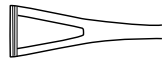

107-12370

107-12370-16	16 cm 6.25"	●
107-12370-20	20 cm 8"	●

Plastic  
Orthopaedic  
Popular Model



**Duval STILLE fattningstång** | Duval STILLE  
Intestinal Grasping Forceps

Intestinal grasping forceps.

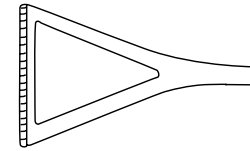

107-12563

107-12563	18 cm 7"
-----------	----------

Plastic  
Orthopaedic  
Popular Model



## Allis STILLE fattningstång | Allis STILLE Intestinal Grasping Forceps

Tissue-grasping forceps for secure grip of tissue.



107-13120

			Plastic	Orthopaedic	Popular Model
107-13120-15	5x6 teeth	15 cm 6"	●	●	●
107-13120-21	5x6 teeth	21 cm 8.25"	●	●	●

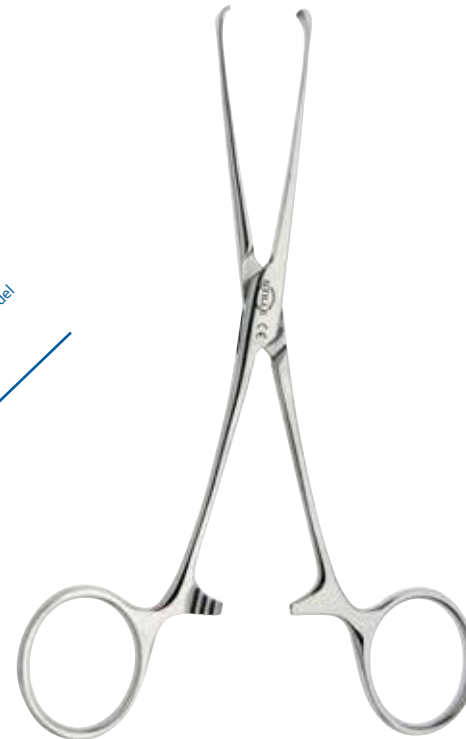

**Allis STILLE fattningstång | Allis STILLE Intestinal Grasping Forceps**

Atraumatic tissue-grasping forceps.

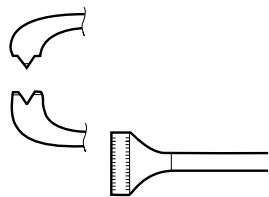

107-13130

				Plastic	Orthopaedic	Popular Model
107-13130-15	Non-traumatic	15,5 cm 6"	<b>NEW</b>	●	●	
107-13130-19	Non-traumatic	19 cm 7.5"	<b>NEW</b>	●	●	
107-13130-25	Non-traumatic	25 cm 10"	<b>NEW</b>	●	●	



## Maier STILLE tvättång | Maier STILLE Sponge Holding Forceps

Sponge holding forceps with serrated jaws. Available straight and curved.

					Plastic	Orthopaedic	Popular Model
107-12478	With ratchet	Straight	26 cm 10.25"	NEW	●	●	
107-12479	With ratchet	Curved	26 cm 10.25"	NEW	●	●	

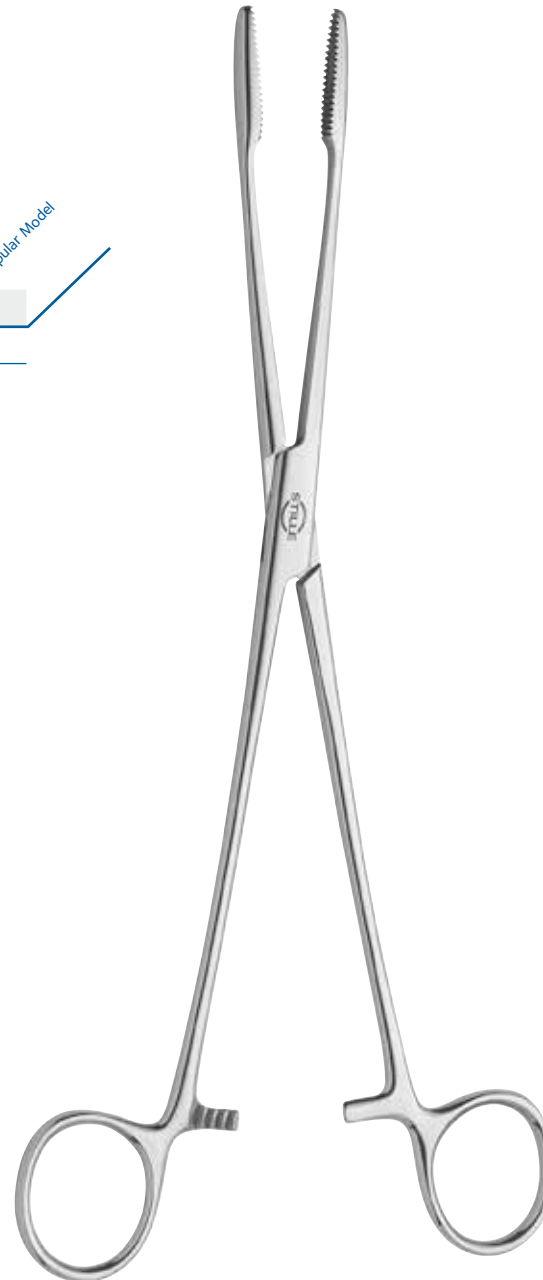

## Foerster STILLE ringtång | Foerster STILLE Sponge Holding Forceps

Sponge holding forceps with several different loops and lengths.



107-12485



107-12487



107-12486



107-12488

					Plastic	Orthopaedic	Popular Model
107-12489	Serrated	Straight	18 cm 7"	NEW	●	●	
107-12490	Serrated	Curved	18 cm 7"	NEW	●	●	
107-12485	Serrated	Straight small	24 cm 9.5"		●	●	●
107-12486	Serrated	Curved small	24 cm 9.5"		●	●	●
107-12487	Serrated	Straight large	24 cm 9.5"		●	●	●
107-12488	Serrated	Curved large	24 cm 9.5"		●	●	●

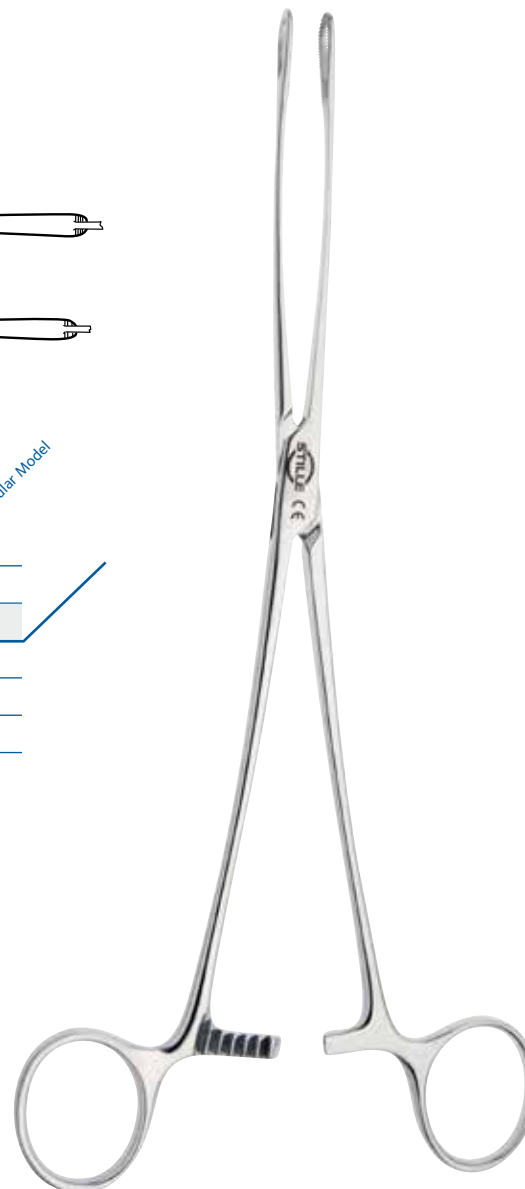



## Schroeder STILLE klotång | Schroeder STILLE Tenaculum Forceps

Uterine tenaculum forceps.

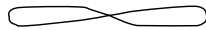

107-13280

107-13280 24 cm 9,5"

Plastic  
Orthopaedic  
Popular Model



## STILLE uterusmanipulator | STILLE Uterine Manipulator

Designed to give better control of the uterus for improved visualization during laparoscopic procedures. Slightly rounded probe with a drop-shaped tip for minimized risk of tissue trauma.

107-13290 Probe 60 mm Curved 26.5 cm 10.5" **NEW**

Plastic  
Orthopaedic  
Popular Model







**DET ÄR VIKTIGT ATT HAKEN** håller undan vävnaden varligt och atraumatiskt. Därför måste blad, klor och skaft vara så mjukt utformade som möjligt. STILLEs hakar har en design med perfekt rundade kanter och mjuk övergång till klor och blad. Ytan är alltid högglanspolerad för att effektivisera rengöringen och öka livslängden. Handtagen är särskilt utformade för att göra instrumenten bekväma att hantera. Flera modeller har försetts med ergonomiskt utformade handtag.

I sortimentet finns även ett antal självhållande hakar som exempelvis Adsonhakar, Perman bukhakar och revbensspridare.

**IS IMPORTANT THAT A RETRACTOR** holds the tissue gently and without causing trauma. Therefore, the blade, teeth and handle must be designed and shaped as smoothly as possible. STILLE retractors are designed with perfectly rounded edges and smooth transitions to blade and teeth. The instrument surface is always highly polished, which streamlines cleaning and increases longevity. The handles are specifically designed to ensure the instruments are comfortable to use. Several models have been equipped with ergonomically designed handles.

The range also includes a number of self retaining models such as Adson retractors, Perman abdominal retractors and rib spreaders.

# Hakar | Retractors | Wundhaken | Divaricatori | Separadores | 開創器、鉤、レトラクター

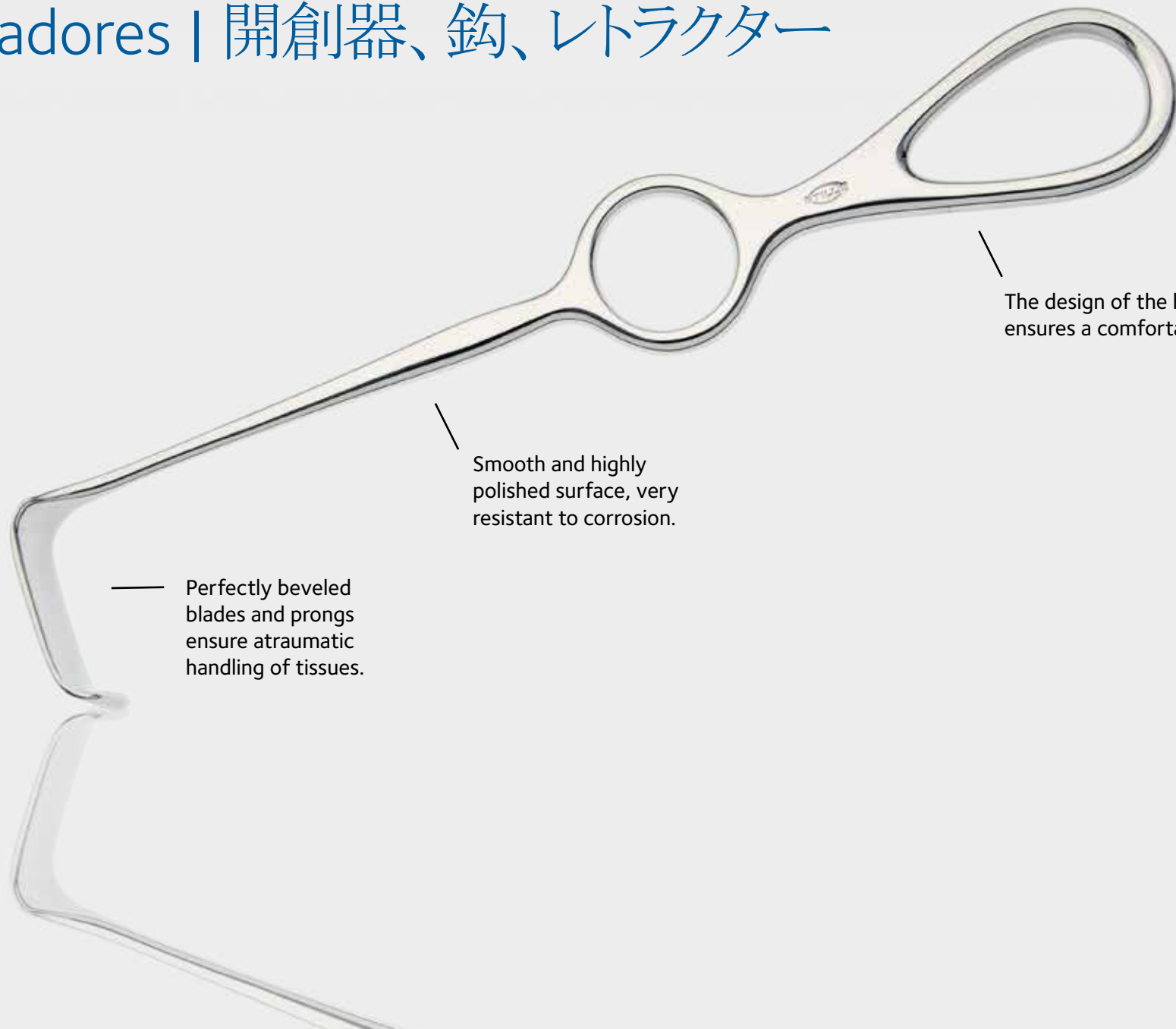

The design of the handle ensures a comfortable grip.

Smooth and highly polished surface, very resistant to corrosion.

Perfectly beveled blades and prongs ensure atraumatic handling of tissues.



### Gillies STILLE hudhake | Gillies STILLE Skin Hook

Skin hook with small or large hook on long flat shaft.



108-24110



108-24112

			Plastic	Orthopaedic	Popular Model
108-24110	Small	19 cm 7.5"	●	●	
108-24112	Large	19 cm 7.5"	●	●	



### Joseph STILLE hudhake | Joseph STILLE Skin Hook

Skin hook with sharp prongs. Available in five different models. Popular in plastic surgery.



108-25011-1



108-25012-2



108-25012-5



108-25012-10

					Plastic	Orthopaedic	Popular Model
108-25011-1	Single hook	16 cm 6.25"	NEW	●			
108-25012-2	Double hook	2 mm 16 cm 6.25"	NEW	●			
108-25012-5	Double hook	5 mm 16 cm 6.25"	NEW	●			
108-25012-7	Double hook	7 mm 16 cm 6.25"	NEW	●			
108-25012-10	Double hook	10 mm 16 cm 6.25"	NEW	●			



## Kleinert-Kutz STILLE hudhake | Kleinert-Kutz STILLE Skin Hook

Skin hook with a sharp single prong in three different sizes. Popular in facial and nasal surgery.



108-25031-3

108-25031-5

108-25031-7

108-25031-3	Small	3 mm	16 cm 6.25"	<b>NEW</b>	●
108-25031-5	Medium	5 mm	16 cm 6.25"	<b>NEW</b>	●
108-25031-7	Large	7 mm	16 cm 6.25"	<b>NEW</b>	●

Plastic  
Orthopaedic  
Popular Model



### STILLE nervhake | STILLE Nerve Hook

Blunt nerve hook on long flat shaft.



108-24320

108-24320	Slightly curved	blunt	22 cm 8.75"	●
-----------	-----------------	-------	-------------	---

Plastic  
Orthopaedic  
Popular Model



### Love STILLE nervhake | Love STILLE Nerve Hook

Nerve root retractor with long flat shaft.

108-26048-7	7 mm	20.5 cm 8"	<b>NEW</b>	●
-------------	------	------------	------------	---

Plastic  
Orthopaedic  
Popular Model





### Moberg STILLE hake | Moberg STILLE Retractor

Retractor with flat handle for facial- and hand surgery.

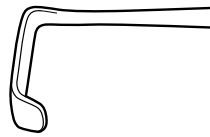

108-24380

108-24380	14x5 mm	17 cm 6.75"	●	●	●
-----------	---------	-------------	---	---	---

Plastic  
Orthopaedic  
Popular Model



### Strandell STILLE hake | Strandell STILLE Retractor

Retractor with two different blade lengths. Blades with teeth.

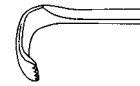

108-24385-8

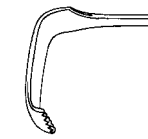

108-24385-15

108-24385-8	With teeth	8x5 mm	19 cm 7.5"	●	●
108-24385-15	With teeth	15x5 mm	19 cm 7.5"	●	●

Plastic  
Orthopaedic  
Popular Model



### STILLE hake | STILLE Retractor

Retractor with one, two or three prongs, sharp or blunt.

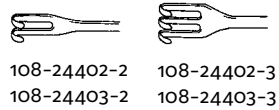
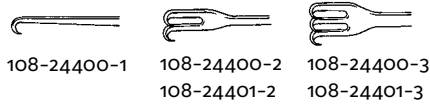

						Plastic	Orthopaedic	Popular Model
108-24400-1	Sharp	1 prong		18 cm 7"	●	●		
108-24400-2	Sharp	2 prongs	6 mm	18 cm 7"	●	●		
108-24400-3	Sharp	3 prongs	9 mm	18 cm 7"	●	●		
108-24401-2	Ergo	Sharp	2 prongs	6 mm	18 cm 7"	●	●	
108-24401-3	Ergo	Sharp	3 prongs	9 mm	18 cm 7"	●	●	
108-24402-2	Blunt	2 prongs	6 mm	18 cm 7"	●	●		
108-24402-3	Blunt	3 prongs	9 mm	18 cm 7"	●	●		
108-24403-2	Ergo	Blunt	2 prongs	6 mm	18 cm 7"	●	●	
108-24403-3	Ergo	Blunt	3 prongs	9 mm	18 cm 7"	●	●	



### Volkmann STILLE hake | Volkmann STILLE Retractor

Retractor with one to four prongs. Sharp or blunt.

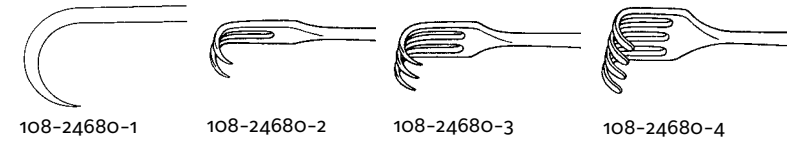

						Plastic	Orthopaedic	Popular Model
108-24680-1	Sharp	1 prong	Large	21.5 cm 8.5"	●	●		
108-24680-2	Sharp	2 prongs		22 cm 8.75"	●	●		
108-24680-3	Sharp	3 prongs		22 cm 8.75"	●	●		
108-24680-4	Sharp	4 prongs		22 cm 8.75"	●	●		
108-24682-2	Blunt	2 prongs		22 cm 8.75"	●	●		
108-24682-3	Blunt	3 prongs		22 cm 8.75"	●	●		
108-24682-4	Blunt	4 prongs		22 cm 8.75"	●	●		



### Ragnell STILLE hake | Ragnell STILLE Retractor

Double-ended retractor for plastic and reconstructive surgery.

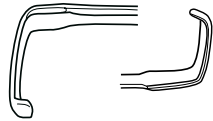

108-24808

				Plastic	Orthopaedic	Popular Model
108-24808	Double ended	9x3/15x5 mm	15 cm 6"	●	●	●



### Langenbeck STILLE hake | Langenbeck STILLE Retractor

General operating retractor with a variety of blade sizes.

				Plastic	Orthopaedic	Popular Model
108-24812-7	20x7 mm	21 cm 8.25"		●	●	●
108-24814-10	30x10 mm	21 cm 8.25"		●	●	●
108-24814-15	30x15 mm	21 cm 8.25"		●	●	●
108-24814-20	30x20 mm	21 cm 8.25"		●	●	●
108-24816-20	45x20 mm	21 cm 8.25"		●	●	●

### Millard STILLE tumringshake | Millard STILLE Thumb Ring Retractor

Thumb ring retractor with two sharp prongs. Fits on the surgeon's thumb. Popular in rhinoplasty.

108-25027	Double prong	5.5 cm 2"	<b>NEW</b>	●	Plastic Orthopaedic Popular Model
-----------	--------------	-----------	------------	---	---



### Aufricht STILLE näshake | Aufricht STILLE Nasal Retractor

Nasal retractor with concave blade.

108-26011	46x10 mm	16 cm 6.25"	<b>NEW</b>	●	Plastic Orthopaedic Popular Model
-----------	----------	-------------	------------	---	---



### Senn STILLE hake | Senn STILLE Retractor

Double-ended retractor for plastic surgery.

108-25940	15x5 mm	3 sharp prongs	15 cm 6"	● ● ●	Plastic Orthopaedic Popular Model
-----------	---------	----------------	----------	-------	---



### Converse STILLE nashake | Converse STILLE Nasal Retractor

Nasal retractor with concave blade. Curved handle for better grip.

			Plastic	Orthopaedic	Popular Model
108-26015	11.5 cm 4.5"	<b>NEW</b>	●		

### Deaver STILLE hake | Deaver STILLE Retractor

Flexible standard retractor for breast- and facial surgery.

				Plastic	Orthopaedic	Popular Model
108-26037-19	19 mm 17.5 cm 6.75"	<b>NEW</b>		●	●	
108-26037-22	22 mm 20 cm 8"	<b>NEW</b>		●	●	
108-26037-25	25 mm 30 cm 12"	<b>NEW</b>		●	●	



Regarding new products, please see [www.stille.se](http://www.stille.se) for latest update. Product images to be added in next printed edition.

### STILLE brösthake | STILLE Breast Retractor

Useful double-sided retractor for breast augmentation. Serrated blades in two different sizes and shapes. Ergonomic handle for maximum comfort.



108-26038 Double-ended black coated handle 23 cm 9" ●

Plastic  
Orthopaedic  
Popular Model

### Julian STILLE Facelift hake | Julian STILLE Face-lift Retractor

Facelift retractor with angled blade and handle for a comfortable grip and good visibility.



108-26041 Angled 23 mm 11.5 cm 4.5" **NEW** ●

Plastic  
Orthopaedic  
Popular Model

Regarding new products, please see [www.stille.se](http://www.stille.se) for latest update. Product images to be added in next printed edition.

### Julian STILLE nashake | Julian STILLE Nasal Retractor

Double prong nasal retractor with thumb ring grip.

108-26043	2 sharp prongs	11,5 cm 4.5"	<b>NEW</b>	●	Plastic Orthopaedic Popular Model
-----------	----------------	--------------	------------	---	---



### Desmarres STILLE ögonlockshake | Desmarres STILLE Eye-lid Retractor

For lid retraction in blepharoplasty. Available in four different sizes, with or without insulation.

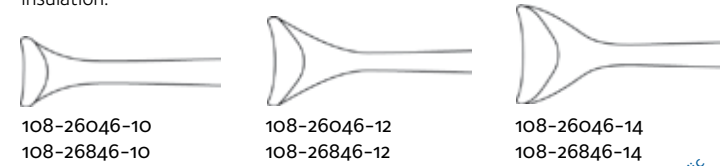

108-26046-10  
108-26846-10

108-26046-12  
108-26846-12

108-26046-14  
108-26846-14

108-26046-8		8 mm	14 cm 5.5"	<b>NEW</b>	●	Plastic Orthopaedic Popular Model
108-26046-10		10 mm	14 cm 5.5"	<b>NEW</b>	●	
108-26046-12		12 mm	14 cm 5.5"	<b>NEW</b>	●	
108-26046-14		14 mm	14 cm 5.5"	<b>NEW</b>	●	
108-26846-8	Insulated	8 mm	14 cm 5.5"	<b>NEW</b>	●	
108-26846-10	Insulated	10 mm	14 cm 5.5"	<b>NEW</b>	●	
108-26846-12	Insulated	12 mm	14 cm 5.5"	<b>NEW</b>	●	
108-26846-14	Insulated	14 mm	14 cm 5.5"	<b>NEW</b>	●	

Regarding new products, please see [www.stille.se](http://www.stille.se) for latest update. Product images to be added in next printed edition.

### Freeman STILLE hake | Freeman STILLE Retractor

Rake retractor with four sharp prongs. Useful in facelift procedures. The two inner prongs are slightly shorter to distribute the pressure on the tissue better.

108-26052-22    22 mm    18 cm 7"    **NEW**    ●

Plastic  
Orthopaedic  
Popular Model

### Freeman STILLE Facelift hake | Freeman STILLE Facelift Retractor

A wider version of the Freman STILLE retractor. Useful in facelift procedures.

108-26052-38    38 mm    18 cm 7"    **NEW**    ●

Plastic  
Orthopaedic  
Popular Model

Regarding new products, please see [www.stille.se](http://www.stille.se) for latest update. Product images to be added in next printed edition.



## Doyen STILLE bukhake | Doyen STILLE Abdominal Retractor

The famous STILLE-design abdominal retractor with a variety of blade sizes.  
The handle is rotated 90° for maximum comfort.

Plastic  
Orthopaedic  
Popular Model

108-24930-20	90x20mm	22 cm 8.75"	
108-24930-30	90x30mm	22 cm 8.75"	
108-24935-35	110x35mm	22 cm 8.75"	
108-24935-40	110x40mm	22 cm 8.75"	
108-24935-55	110x55mm	22 cm 8.75"	
108-24940-55	120x55 mm	24 cm 9.5"	<b>NEW</b>



## Perman STILLE bukhahe | Perman STILLE Abdominal Retractor

Self-retaining abdominal retractor. Can be custom designed in various sizes.

108-26865    Depth 65 mm    Arm length 18 cm 7"

Plastic  
Orthopaedic  
Popular Model



## Kocher STILLE bukspatel | Kocher STILLE Abdominal Spatula

STILLE's classical abdominal spatula, available in three different sizes.  
Also used in orthopaedics.

				Plastic	Orthopaedic	Popular Model
108-23780-25	25 mm	22 cm 8,5"	<b>NEW</b>	●		
108-23780-35	35 mm	22 cm 8,5"	<b>NEW</b>	●		
108-23780-45	45 mm	22 cm 8,5"	<b>NEW</b>	●		



### Carlens STILLE Tracheotomihake | Carlens STILLE Trachea Retractor

Double-ended trachea retractor.

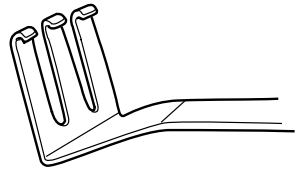

108-24805

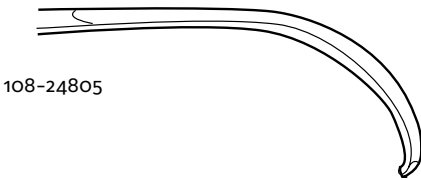

Plastic  
Orthopaedic  
Popular Model

108-24805 Double-ended 22 cm 8.75"



## Weitlaner STILLE hake | Weitlaner STILLE Retractor

General purpose self-retaining retractor used in many procedures.

				Plastic	Orthopaedic	Popular Model
108-26252	2x3 sharp prongs	10.5 cm 4.25"	<b>NEW</b>	●	●	
108-26253	2x3 blunt prongs	10.5 cm 4.25"	<b>NEW</b>	●	●	
108-26254	3x4 sharp prongs	13.5 cm 5.25"	<b>NEW</b>	●	●	
108-26255	3x4 blunt prongs	13.5 cm 5.25"	<b>NEW</b>	●	●	
108-26256	3x4 sharp prongs	16.5 cm 6.5"	<b>NEW</b>	●	●	
108-26257	3x4 blunt prongs	16.5 cm 6.5"	<b>NEW</b>	●	●	



## Alm STILLE hake | Alm STILLE Retractor

Self-retaining retractor for fine incisions. Available in two different sizes.

				Plastic	Orthopaedic	Popular Model
108-26261	4x4 sharp prongs	7 cm 2.75"	<b>NEW</b>	●		
108-26262	4x4 sharp prongs	10 cm 4"	<b>NEW</b>	●		



Adson STILLE självhållande hake | Adson STILLE  
Self Retaining Retractor

Self retaining retractor with sharp prongs. Available in two different sizes.

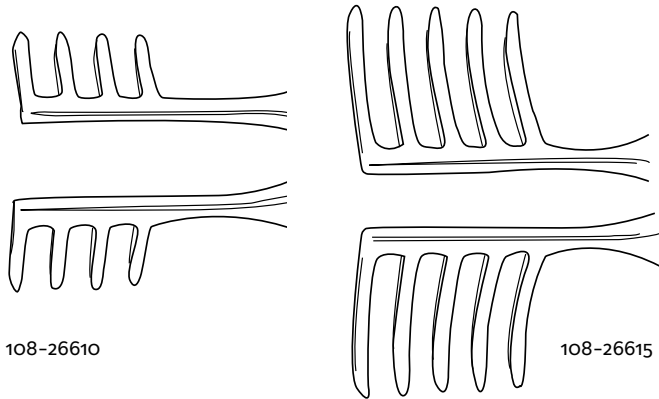

108-26610

108-26615

Plastic  
Orthopaedic  
Popular Model

108-26610	4x4 sharp prongs	25 mm	32 cm 12.5"	●	●
108-26615	5x5 sharp prongs	45 mm	32 cm 12.5"	●	●



## Finochietto STILLE revbensspridare | Finochietto STILLE Rib Spreader

Sternum and rib spreader with interchangeable blades.

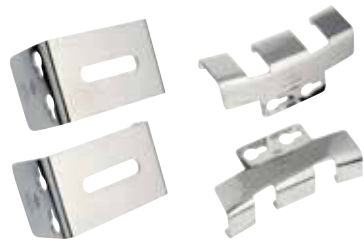

108-26931-80

108-26931-100

108-26931	Self-retaining	with blades 50x50 mm
108-26931-80	Blades	1 pair 80x50 mm
108-26931-100	Blades	1 pair 30x100 mm

Plastic  
Orthopaedic  
Popular Model



### Vienna STILLE nässpekulum | Vienna STILLE Nasal Speculum

Nasal speculas in three different sizes.

				Plastic	Orthopaedic	Popular Model
108-27011-1	24 mm	14 cm 5.5"	<b>NEW</b>	●		
108-27011-2	30 mm	14 cm 5.5"	<b>NEW</b>	●		
108-27011-3	34 mm	14 cm 5.5"	<b>NEW</b>	●		



### Cottle STILLE nässpekulum | Cottle STILLE Nasal Speculum

Nasal speculum with locking screw.

				Plastic	Orthopaedic	Popular Model
108-27021-2	55 mm	14 cm 5.5"	<b>NEW</b>	●		









**SCRAPING, UNCOVERING OR REMOVAL** of soft and hard tissue and other precision work requires a light touch. The instruments must be strong, yet flexible enough to avoid damage.

STILLE offers an assortment of curettes, raspatories, dissectors and elevators of the very highest quality. The material is highly polished stainless steel with precisely the qualities that are so important for these types of instruments. The steel is hard enough to deal with hard bone tissue and to remain sharp, yet flexible enough to avoid damaging implants.

This instrument group also includes STILLE's well known uterine curettes. They are designed with shafts of unhardened stainless steel, which gives them the precise flexibility required. The instruments need not be coated with a surface layer of nickel, which prolongs durability and increases patient safety.

**SKRAPNING, FRILÄGGNING ELLER BORTTAGNING** av mjuk och hård vävnad samt andra precisa arbeten kräver ett lätt handlag. Instrumenten måste vara starka men samtidigt följsamma för att undvika skador.

STILLE erbjuder ett sortiment av kyretter, raspatorier, dissektorer och elevatorier av allra högsta kvalitet. Materialet är högglanspolerat rostfritt stål med just de egenskaper som är så viktiga för denna typ av produkter. Stålet är tillräckligt hårt för att hantera hård benvävnad och hålla sig vasst samtidigt som det måste vara följsamt för att inte skada implantat.

I den här produktgruppen ingår också STILLES välkända uteruskyretter. De tillverkas numera med skaft av ohärdat rostfritt stål vilket ger dem de precisa böjbara egenskaperna som behövs. Instrumentet behöver inte beläggas med ett ytskikt av nickel vilket förlänger hållbarheten och ökar patientsäkerheten.



Slevar, Raspatorier, Elevatorier etc. | Currettes,  
Raspatories, Elevators etc. | Löffel, Raspatorien,  
Elevatorien etc. | Curette, Staccaperiostio,  
Elevatori etc. | Cucharillas, Legras, Elevadores etc. |  
鋭匙、やすり骨膜起子



## Récamier STILLE uteruskyrett | Récamier STILLE Uterine curette

Malleable uterine curettes in different sizes. With shaft in non-hardened stainless steel, ensures long-time function without any surface coating falling off. Higher patient safety and longer life-time expectancy.

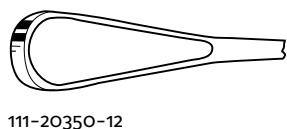
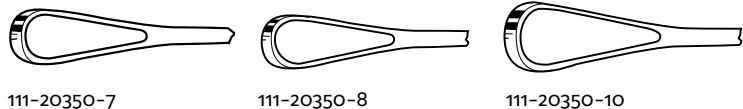
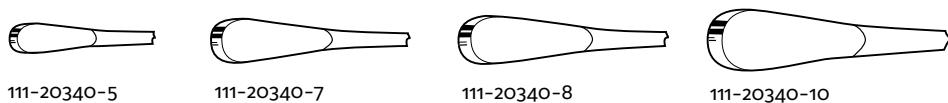

Plastic  
Orthopaedic  
Popular Model

111-20340-5	Sharp	5 mm	30 cm 12"
111-20340-7	Sharp	7 mm	30 cm 12"
111-20340-8	Sharp	8 mm	30 cm 12"
111-20340-10	Sharp	10 mm	30 cm 12"
111-20350-7	Blunt	7 mm	30 cm 12"
111-20350-8	Blunt	8 mm	30 cm 12"
111-20350-10	Blunt	10 mm	30 cm 12"
111-20350-12	Blunt	12 mm	30 cm 12"





### STILLE slev | STILLE Bone curette

Oval and sharp bone curettes with widths from 2 mm to 12 mm.

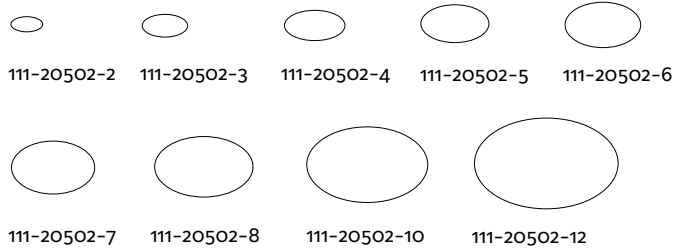

Model	Tip Shape	Width	Length	Plastic	Orthopaedic	Popular Model
111-20502-2	Sharp oval	2 mm	17.5 cm 7"	●	●	
111-20502-3	Sharp oval	3 mm	18 cm 7"	●	●	
111-20502-4	Sharp oval	4 mm	18.5 cm 7.25"	●	●	
111-20502-5	Sharp oval	5 mm	18.5 cm 7.25"	●	●	
111-20502-6	Sharp oval	6 mm	18.5 cm 7.25"	●	●	
111-20502-7	Sharp oval	7 mm	19 cm 7.5"		●	
111-20502-8	Sharp oval	8 mm	19.5 cm 7.75"		●	
111-20502-10	Sharp oval	10 mm	21 cm 8.25"		●	
111-20502-12	Sharp oval	12 mm	21 cm 8.25"		●	



### STILLE slev | STILLE Bone curette

Oval and sharp bone curettes with widths from 2 mm to 6 mm. Longer Shaft version.

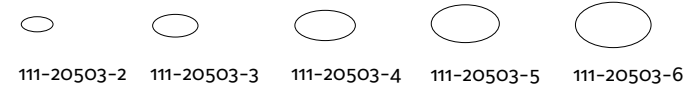

Model	Tip Shape	Width	Length	Plastic	Orthopaedic	Popular Model
111-20503-2	Sharp oval	2 mm	23 cm 9"		●	
111-20503-3	Sharp oval	3 mm	23 cm 9"		●	
111-20503-4	Sharp oval	4 mm	23 cm 9"		●	
111-20503-5	Sharp oval	5 mm	23 cm 9"		●	
111-20503-6	Sharp oval	6 mm	23 cm 9"		●	



### Olivecrona STILLE raspatorium | Olivecrona STILLE Raspatory

Raspatory with sturdy and ergonomic handle. Curved tip.



111-22150

111-22150	Curved	11 mm	17 cm 6.75"	<ul style="list-style-type: none"> <li>Plastic</li> <li>Orthopaedic</li> <li>Popular Model</li> </ul>
-----------	--------	-------	-------------	---

### Cobb STILLE raspatorium | Cobb STILLE Raspatory

Popular raspatory with round handle. Available with several different tip sizes.

				Plastic	Orthopaedic	Popular Model
111-22155-10	10 mm	28,5 cm 11.25"	<b>NEW</b>	●		
111-22155-13	13 mm	28,5 cm 11.25"	<b>NEW</b>	●		
111-22155-19	19 mm	28,5 cm 11.25"	<b>NEW</b>	●		
111-22155-25	25 mm	28,5 cm 11.25"	<b>NEW</b>	●		





### Cottle STILLE raspatorium | Cottle STILLE Raspatory

Commonly used raspatory with a sharp 9 mm rounded tip.

111-22158-9	9 mm	19 cm 7.5"	<b>NEW</b>	Plastic	Orthopaedic	Popular Model
-------------	------	------------	------------	---------	-------------	---------------



### Lambotte STILLE raspatorium | Lambotte STILLE Raspatory

Raspatory with a wide 23 mm tip.

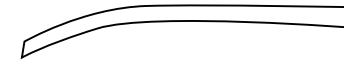

111-22160				Plastic	Orthopaedic	Popular Model
111-22160	Curved	23 mm	21 cm 8.25"			



### Wiberg STILLE raspatorium | Wiberg STILLE Raspatory

A straight raspatorium in four different sizes.

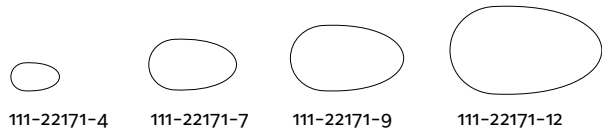

				Plastic	Orthopaedic	Popular Model
111-22171-4	Straight	4 mm	17 cm 6.75"	●	●	
111-22171-7	Straight	7 mm	17 cm 6.75"	●	●	
111-22171-9	Straight	9 mm	17 cm 6.75"	●	●	
111-22171-12	Straight	12mm	17 cm 6.75"	●	●	



### Ragnell STILLE raspatorium | Ragnell STILLE Raspatory

Double-ended raspatorium with blunt hooks.

			Plastic	Orthopaedic	Popular Model
111-22350	Blunt hook	17 cm 6.75"	●		





### Howarth STILLE näsraspatorium | Howarth STILLE Nasal Raspatory

Double-ended nasal raspatory with sharp hooks.

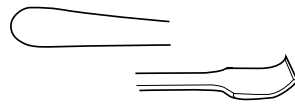

111-22370

111-22370	Double-ended	22 cm 8.75"	●	●	●
-----------	--------------	-------------	---	---	---

Plastic  
Orthopaedic  
Popular Model



### Joseph STILLE raspatorium | Joseph STILLE Raspatory

Slightly curved raspatory with flat handle.

111-22385-4	4 mm	17 cm 6.75"	NEW	●	●
-------------	------	-------------	-----	---	---

Plastic  
Orthopaedic  
Popular Model



### STILLE näsraspatorium | STILLE Nasal Raspatory

Sharp, slightly curved nasal raspatory.

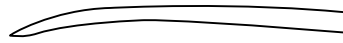

111-22520-4

111-22520-4 Slightly curved Sharp 4 mm 18 cm 7"

Plastic

Orthopaedic

Popular Model





### Freer STILLE elevatorium | Freer STILLE Elevator

Double-ended elevator sharp/blunt with rounded, delicate handle.

					Plastic	Orthopaedic	Popular Model
111-22140-4	4.5 mm	19.5 cm 7.75"	<b>NEW</b>	●			
111-22140-6	6.5 mm	19.5 cm 7.75"	<b>NEW</b>	●			



### STILLE näselevatorium | STILLE Nasal Elevator

Blunt nasal elevator.

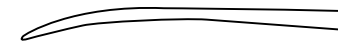

111-22522-4

					Plastic	Orthopaedic	Popular Model
111-22522-4	Slightly curved blunt	4 mm	18 cm 7"	●			



Cottle STILLE septum elevatorium | Cottle STILLE Septum Elevator

Double-ended fine elevator with graduated shafts.

111-22532	Graduated	3.3/3.7 mm	23 cm 9"	<b>NEW</b>	●
-----------	-----------	------------	----------	------------	---

Plastic  
Orthopaedic  
Popular Model



Langenbeck STILLE elevatorium | Langenbeck STILLE Elevator

Sturdy elevator mainly used in orthopaedics. Available in two sizes.

111-22550-8	8 mm	19.5 cm 7.75"	<b>NEW</b>	●
111-22550-10	10 mm	19.5 cm 7.75"	<b>NEW</b>	●

Plastic  
Orthopaedic  
Popular Model



### Mini-Hohmann STILLE elevatorium | Mini-Hohmann STILLE Elevator

Finer version of the Hohmann elevator. Used in foot surgery.

						Plastic	Orthopaedic	Popular Model
111-22565-6	Bone lever	6 mm	16 cm 6.25"	<b>NEW</b>		●		
111-22565-8	Bone lever	8 mm	16 cm 6.25"	<b>NEW</b>		●		



### Hohmann STILLE elevatorium | Hohmann STILLE Elevator

General utility bone lever for orthopaedic surgery.

						Plastic	Orthopaedic	Popular Model
111-22567-9	Rounded	9 mm	22 cm 8.75"	<b>NEW</b>		●		
111-22568-18	Rounded	18 mm	24 cm 9.5"	<b>NEW</b>		●		
111-22569-18	Flat	18 mm	25.5 cm 10"	<b>NEW</b>		●		
111-22569-24	Flat	24 mm	26 cm 10.25"	<b>NEW</b>		●		



### STILLE elevatorium | STILLE Elevator

Standard bone lever in two different sizes.

					Plastic	Orthopaedic	Popular Model
111-22563-3	3 mm	14.5 cm 5.75"	<b>NEW</b>		●		
111-22563-6	6 mm	14.5 cm 5.75"	<b>NEW</b>		●		



### Stolte STILLE tonsillelevatorium | Stolte STILLE Tonsil Elevator

Curved double-ended tonsil elevator.

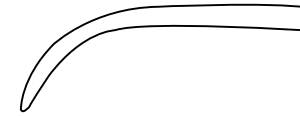

111-22635

				Plastic	Orthopaedic	Popular Model
111-22635	Double-ended	20 cm 8"		●		



## STILLE dissektor | STILLE Dissector

Double-ended dissector in several different models.

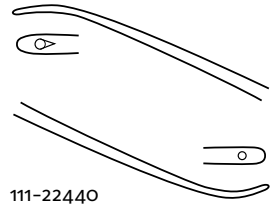

111-22440

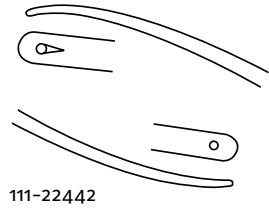

111-22442

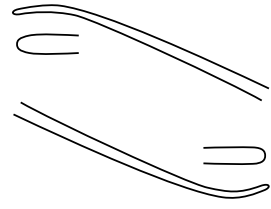

111-22440

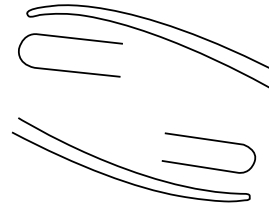

111-22442

Plastic  
Orthopaedic  
Popular Model

111-22440-18	Fine with hole	18 cm 7"	
111-22440-24	Fine with hole	24 cm 9.5"	
111-22442-19	Coarse with hole	19.5 cm 7.75"	
111-22442-24	Coarse without hole	24 cm 9.5"	●
111-22444	Fine without hole	24.5 cm 9.75"	●
111-22446	Coarse without hole	24.5 cm 9.5"	



### Fomon STILLE rasp | Fomon STILLE Rasp

Double-ended rasp with TC-inserts for better durability. Low profile for better access in narrow areas.

				Plastic	Orthopaedic	Popular Model
111-22860	TC-inserts 1&2	21.5 cm 8.5"	<b>NEW</b>	●		
111-22861	TC-inserts 3&4	21.5 cm 8.5"	<b>NEW</b>	●		
111-22862	TC-inserts 5&6	21.5 cm 8.5"	<b>NEW</b>	●		
111-22863	TC-inserts 7&8	21.5 cm 8.5"	<b>NEW</b>	●		

### Peet STILLE näsrasp | Peet STILLE Nasal Rasp

TC-rasp with sturdy handle. Available with straight and curved blade.

					Plastic	Orthopaedic	Popular Model
111-22870	TC-insert	Straight	19 cm 7.5"	<b>NEW</b>	●		
111-22871	TC-insert	Curved	19 cm 7.5"	<b>NEW</b>	●		

### Aufricht STILLE glabellarasp | Aufricht STILLE Glabella Rasp

Glabella rasp with TC-insert.

					Plastic	Orthopaedic	Popular Model
111-22873	TC-insert		20.5 cm 8"	<b>NEW</b>	●		



Regarding new products, please see [www.stille.se](http://www.stille.se) for latest update. Product images to be added in next printed edition.







**OSTEOTOMER, MEJSLAR, GOUGEMEJSLAR** och andra beninstrument från STILLE tillverkas i ett härdat kvalitetsstål med särskilt hög hårdhet för att undvika brytskador eller böjningar. Hårdheten ökar tåligheten mot slitage och stålets seghet avgör hur väl det står emot stora påfrestningar under lång tid.

Det är valet av material med precis rätt hårdhet (HRC-värde) i kombination med tillverkningsmetod som ger instrumentet dess unika skäregenskaper. Eggen är lagd i en perfekt vinkel för maximal skärprestanda. Spetsen är hård nog för att den inte ska fastna i benet. Samtidigt är den mjuk nog för att ge med sig i kontakt med implantat.

Specialslipningen gör att instrumenten förblir vassa under en längre tid innan de behöver slipas om. Handtagen är ergonomiskt utformade för ett handfast grepp. STILLE var först i världen med att tillverka osteotomer och instrumenten har genom åren blivit kända för sina unika egenskaper. Den klassiska STILLE-osteotomen är idag ett begrepp över hela världen.

**OSTEOTOMES, CHISELS, MALLETS** and other bone instruments from STILLE are made of high quality hardened steel, with particularly high strength to avoid breakage or bending. The hardness increases resistance to wear and the toughness of the steel determines how well the instrument can withstand great strain for long periods of time.

The choice of material with just the right hardness value (HRC) in combination with the manufacturing method provides the instrument with its unique cutting properties. The edges are placed at the perfect angle for maximum cutting performance. The tip is stiff enough so that it will not get caught in the bone, and soft enough to give way when in contact with implants.

Special sharpening techniques allow the instruments to remain sharp for extended periods before they need to be resharpened. The handles are ergonomically designed for a firm and comfortable grip. STILLE was the first in the world to manufacture osteotomes and over the years the instruments have become known for their unique properties. The classic STILLE osteotome is known the world over.



Osteotomer, mejslar etc. | Osteotomes, Chisels etc. |  
Osteotome, Flachmeissel etc. | Osteotomi, Scalpelli etc. |  
Escoplos, Cinceles etc. | 両刃のみ 片刃のみ



High HRC ensures that the instruments stay sharp.

Handle designed to ensure perfect grip and ergonomomy.

Highest quality steel and hardening for maximum life expectancy.

Special tip grinding for maximum cutting performance.

### STILLE osteotom | STILLE Osteotome

The famous STILLE original osteotome, available in 5 different sizes.

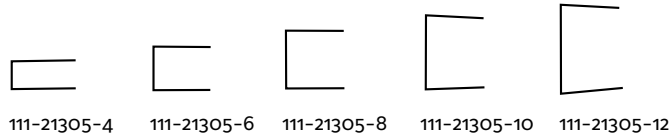

111-21305-4    111-21305-6    111-21305-8    111-21305-10    111-21305-12

			Plastic	Orthopaedic Popular Model
111-21305-4	4 mm	21 cm 8.25"	●	●
111-21305-6	6 mm	21 cm 8.25"	●	●
111-21305-8	8 mm	21 cm 8.25"	●	
111-21305-10	10 mm	21 cm 8.25"	●	
111-21305-12	12 mm	21 cm 8.25"	●	



### STILLE osteotom | STILLE Osteotome

Delicate osteotome with cross-serrated head. Available in 5 different sizes.

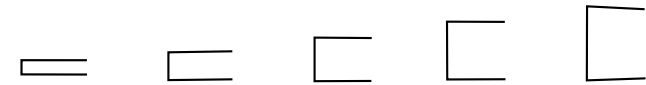

111-21306-2    111-21306-4    111-21306-6    111-21306-8    111-21306-10

			Plastic	Orthopaedic Popular Model
111-21306-2	2 mm	16.5 cm 6.6"	●	●
111-21306-4	4 mm	16.5 cm 6.5"	●	●
111-21306-6	6 mm	16.5 cm 6.5"	●	●
111-21306-8	8 mm	16.5 cm 6.5"	●	●
111-21306-10	10 mm	16.5 cm 6.5"	●	●





### STILLE osteotom | STILLE Osteotome

Osteotome in 5 different sizes. Slightly thicker blade than the STILLE-Kaye osteotome.

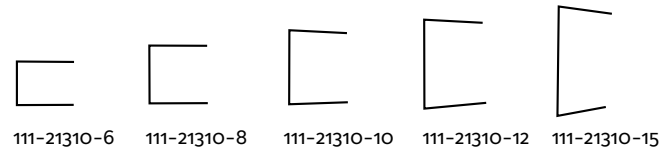

111-21310-6    111-21310-8    111-21310-10    111-21310-12    111-21310-15

			Plastic	Orthopaedic	Popular Model
111-21310-6	6 mm	16,5 cm 6.5"		●	
111-21310-8	8 mm	16,5 cm 6.5"		●	
111-21310-10	10 mm	16,5 cm 6.5"		●	
111-21310-12	12 mm	16,5 cm 6.5"		●	
111-21310-15	15 mm	16,5 cm 6.5"		●	



### STILLE osteotom | STILLE Osteotome

Osteotome available in 6 different sizes.

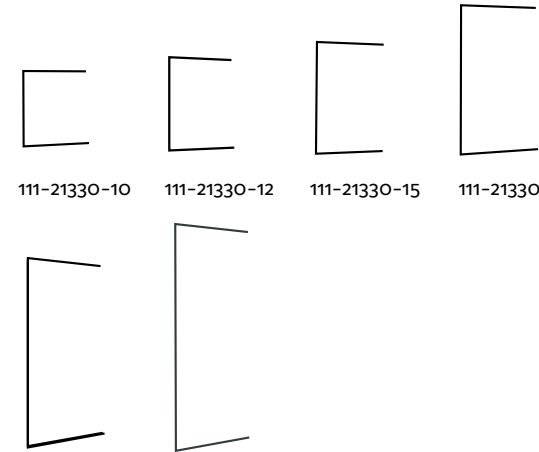

111-21330-10    111-21330-12    111-21330-15    111-21330-20

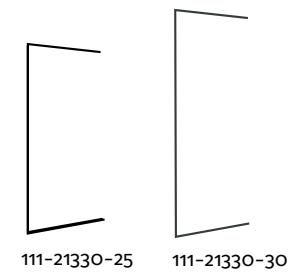

111-21330-25    111-21330-30

			Plastic	Orthopaedic	Popular Model
111-21330-10	10 mm	21 cm 8.25"		●	
111-21330-12	12 mm	21 cm 8.25"		●	
111-21330-15	15 mm	21 cm 8.25"		●	
111-21330-20	20 mm	21 cm 8.25"		●	
111-21330-25	25 mm	21 cm 8.25"		●	
111-21330-30	30 mm	21 cm 8.25"		●	



### Lambotte STILLE osteotom | Lambotte STILLE Osteotome

Straight osteotome available in 6 different sizes.

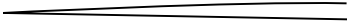

111-21441

				Plastic	Orthopaedic	Popular Model
111-21441-7	Straight	7 mm	23 cm 9"	●	●	
111-21441-15	Straight	15 mm	23 cm 9"	●		
111-21441-20	Straight	20 mm	23 cm 9"	●		
111-21441-25	Straight	25 mm	23 cm 9"	●		
111-21441-30	Straight	30 mm	23 cm 9"	●		
111-21441-40	Straight	40 mm	23 cm 9"	●		



### Lambotte STILLE osteotom | Lambotte STILLE Osteotome

Curved version of the Lambotte osteotome available in 4 different sizes.

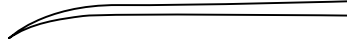

111-21442

				Plastic	Orthopaedic	Popular Model
111-21442-7	Curved	7 mm	23 cm 9"	●		
111-21442-15	Curved	15 mm	23 cm 9"	●		
111-21442-20	Curved	20 mm	23 cm 9"	●		
111-21442-25	Curved	25 mm	23 cm 9"	●		



## Lambotte STILLE miniosteotom | Lambotte STILLE Mini Osteotome

Delicate mini osteotome in 11 different sizes.

111-21450				Plastic	Orthopaedic	Popular Model
111-21450-2	Straight	2 mm	12.5 cm 5"	●	●	
111-21450-3	Straight	3 mm	12.5 cm 5"	●	●	
111-21450-4	Straight	4 mm	12.5 cm 5"	●	●	
111-21450-5	Straight	5 mm	12.5 cm 5"	●	●	
111-21450-6	Straight	6 mm	12.5 cm 5"	●	●	
111-21450-7	Straight	7 mm	12.5 cm 5"	●	●	
111-21450-8	Straight	8 mm	12.5 cm 5"	●	●	
111-21450-9	Straight	9 mm	12.5 cm 5"	●	●	
111-21450-10	Straight	10 mm	12.5 cm 5"	●	●	
111-21450-11	Straight	11 mm	12.5 cm 5"	●	●	
111-21450-12	Straight	12 mm	12.5 cm 5"	●	●	



### STILLE handosteotom | STILLE Hand Osteotome

Delicate osteotome with phenolic handle. Intended for hand surgery, but also useful in other fine orthopaedic work.

			Plastic	Orthopaedic	Popular Model
111-21456-2	2 mm	16cm 6.25"	●	●	
111-21456-4	4 mm	16cm 6.25"	●	●	
111-21456-6	6 mm	16cm 6.25"	●	●	
111-21456-8	8 mm	16cm 6.25"	●	●	
111-21456-10	10 mm	16cm 6.25"	●	●	
111-21456-12	12 mm	16cm 6.25"	●	●	



### Lexer STILLE osteotom | Lexer STILLE Osteotome

Osteotome with phenolic handle.

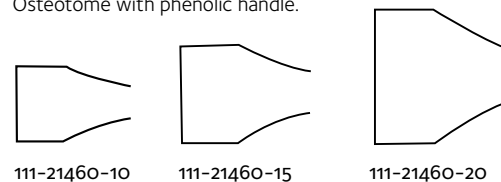

111-21460-10

111-21460-15

111-21460-20

			Plastic	Orthopaedic	Popular Model
111-21460-10	10 mm	21 cm 8.25"		●	
111-21460-15	15 mm	21 cm 8.25"		●	
111-21460-20	20 mm	21 cm 8.25"		●	





### Neivert STILLE osteotom | Neivert STILLE Osteotome

Delicate single-guarded osteotome for lateral osteotomy in rhinoplasty.

111-21501-1	Curved left	20 cm 8"	<b>NEW</b>	●	Plastic Orthopaedic Popular Model
111-21501-2	Curved right	20 cm 8"	<b>NEW</b>	●	
111-21501-3	Straight	20 cm 8"	<b>NEW</b>	●	



### Cinelli STILLE osteotom | Cinelli STILLE Osteotome

Double-guarded osteotome for hump removal.

111-21517-10	10 mm	16 cm 6.25"	<b>NEW</b>	●	Plastic Orthopaedic Popular Model
111-21517-12	12 mm	16 cm 6.25"	<b>NEW</b>	●	
111-21517-14	14 mm	16 cm 6.25"	<b>NEW</b>	●	



### Cottle STILLE osteotom | Cottle STILLE Osteotome

Graduated fine osteotome in five different sizes.

				Plastic	Orthopaedic Popular Model
111-21477-4	4 mm	18 cm 7"	<b>NEW</b>	●	●
111-21477-6	6 mm	18 cm 7"	<b>NEW</b>	●	●
111-21477-8	8 mm	18 cm 7"	<b>NEW</b>	●	●
111-21477-10	10 mm	18 cm 7"	<b>NEW</b>	●	●
111-21477-12	12 mm	18 cm 7"	<b>NEW</b>	●	●



## STILLE mejsel | STILLE Chisel

Original STILLE-design chisel in five different sizes from 6 mm to 15 mm.

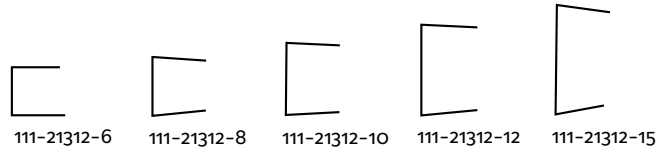

			Plastic	Orthopaedic	Popular Model
111-21312-6	6 mm	16.5 cm 6.5"	●		
111-21312-8	8 mm	16.5 cm 6.5"	●		
111-21312-10	10 mm	16.5 cm 6.5"	●		
111-21312-12	12 mm	16.5 cm 6.5"	●		
111-21312-15	15 mm	16.5 cm 6.5"	●		



### STILLE gougemejsel | STILLE Gouge

Original STILLE gouge. Available in five different sizes from 6 mm to 15 mm.

111-21315-6	111-21315-8	111-21315-10	111-21315-12	111-21315-15	
111-21315-6	6 mm	16.5 cm 6.5"	●	●	Plastic Orthopaedic Popular Model
111-21315-8	8 mm	16.5 cm 6.5"	●	●	
111-21315-10	10 mm	16.5 cm 6.5"	●	●	
111-21315-12	12 mm	16.5 cm 6.5"	●	●	
111-21315-15	15 mm	16.5 cm 6.5"	●	●	

### STILLE gougemejsel | STILLE Gouge

Original STILLE gouge. Available in four different sizes from 10 mm to 20 mm.

111-21335-10	111-21335-12	111-21335-15	111-21335-20	
111-21335-10	10 mm	21 cm 8.25"	●	Plastic Orthopaedic Popular Model
111-21335-12	12 mm	21 cm 8.25"	●	
111-21335-15	15 mm	21 cm 8.25"	●	
111-21335-20	20 mm	21 cm 8.25"	●	



### Parkes STILLE gougemejsel | Parkes STILLE Hump Gouge

Double-guarded hump gouge.

111-21348-18	18 cm 7"	NEW	●	Plastic Orthopaedic Popular Model
--------------	----------	-----	---	---

Regarding new products, please see [www.stille.se](http://www.stille.se) for latest update. Product images to be added in next printed edition.

## STILLE pryl | STILLE Awl

Awl with phenolic handle.



### STILLE hammare | STILLE Mallet

Stainless steel mallet.

111-21820    200 g 7 oz    21.5 cm 8.5"

Plastic  
Orthopaedic  
Popular Model





### STILLE hammare | STILLE Mallet

Mallet with stainless steel head, phenolic handle and interchangeable teflon insert.

				Plastic	Orthopaedic	Popular Model
111-21825	Mallet	145 g, 7 oz	17 cm 6.75"	●	●	
111-21825-5	Spare Teflon insert			●	●	●

### STILLE hammare | STILLE Mallet

Mallet with interchangeable plastic head and stainless steel handle.

				Plastic	Orthopaedic	Popular Model
111-21920	Mallet	245 g, 8.5 oz	24 cm 9.5"	●	●	
111-21920-5	Spare Plastic head			●	●	●





**DE MEST KOMPLICERADE OPERATIONERNA** inom mikrokirurgi kräver högsta precision ända in i minsta detalj. STILLES mikroinstrument är handgjorda av skickliga instrumentmakare och erbjuder perfekt precision och balans.

Sortimentet är i första hand inriktat mot plastikkirurgi och hjärta/-kärlkirurgi. Saxar, pincetter och nålförare finns i flera olika längder och utföranden för att passa alla kirurgers unika önskemål. De svarta handtagen indikerar att instrumentet är ett äkta STILLE-instrument.

**THE MOST COMPLEX MICROSURGICAL PROCEDURES** require precision down to the finest detail. STILLE micro instruments are handmade by skilled craftsman and provide perfect precision and balance.

The instrument range is primarily focused on plastic surgery and cardio/-vascular surgical procedures. Scissors, forceps and needle holders are available in various lengths and designs to suit any surgeon's unique requirements. The black handles indicate that the instrument is an authentic STILLE design.



# Mikroinstrument | Micro instruments | Mikro-instrumente | Strumenti per microchirurgia | Instrumentos para microcirugia | マイクロ器具

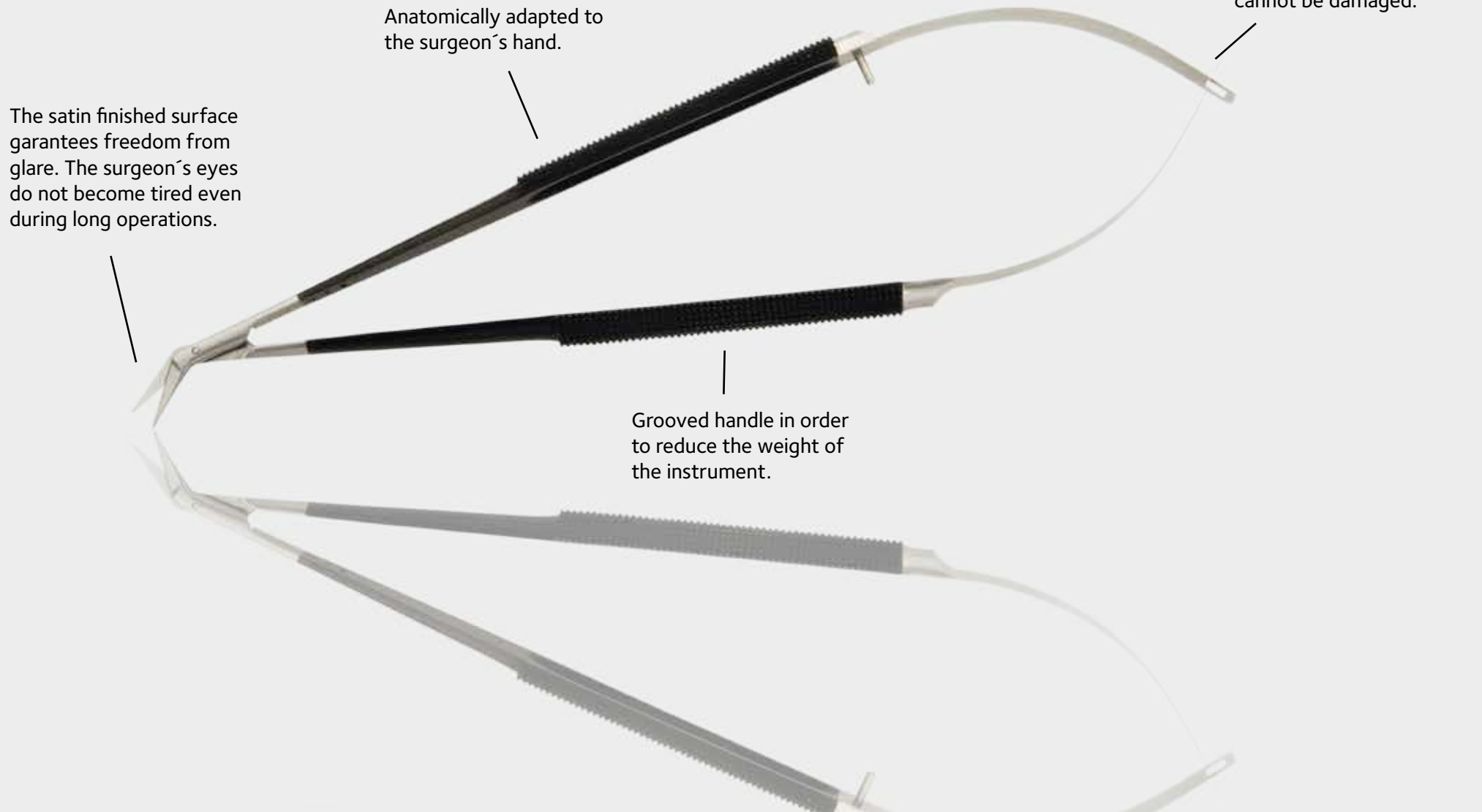



STILLE mikrosax | STILLE Micro Scissors

### MIKROSAXAR

Samtliga mikrosaxar från STILLE är försedda med SuperCut-blad för maximal skärstyrka med minimal kraft och högsta precision ända ut i spetsen. De finns i flera modeller som är raka eller böjda, trubbiga eller spetsiga samt vinklade blad för kärlkirurgi. Mjuka kanter skonar såväl känslig vävnad som suturer och kirurghandskar.

### MICRO SCISSORS

All micro scissors from STILLE feature SuperCut blades for maximum cutting power with minimal effort and precision all the way to the tip. There are several models including straight or curved, blunt, pointed and angled blades for vascular surgery. Soft edges protect both sensitive tissue sutures and surgical gloves.



STILLE mikropincett | STILLE Micro Forceps

### MIKROPINCETTER

Nyper tag lika försiktigt men bestämt som ett par mjuka fingertoppar. Finns i raka och böjda modeller med och utan tänder, suturplattform, ringspetsar och motvikt. Den perfekta fjädringen ger samma känsla som hos övriga STILLE-instrument. Diamond Jaws ger en mer slitstark pincett och är utmärkt för att hantera fina mikronålar.

### MICRO FORCEPS

Tweezing requires sensitivity, gently but firmly like a pair of soft fingertips. Available in straight and curved designs with or without teeth, suture platform, ring tips and counterweight. Perfect spring tension provides the same outstanding feel as other STILLE instruments. Diamond Jaws provide more durability and are excellent for handling fine micro-needles.



STILLE mikronålförare | STILLE Micro Needle Holder

### **MIKRONÅLFÖRARE**

Håller även de minsta suturerna i ett varsamt men säkert grepp med minsta möjliga tryck från fingrarna. Spetsarna har försetts med Diamond Jaws för ökad slitstyrka. Finns i olika längder, raka eller böjda modeller samt med eller utan lås. Passar suturstorlek 6/0 eller mindre.

### **MICRO NEEDLE HOLDERS**

Holds even the smallest suture needles in a gentle but firm grip with minimal finger pressure. The tips feature Diamond Jaws for increased wear resistance. Available in various lengths, straight or curved models, with or without locks. Suitable for suture size 6/0 or smaller.



### STILLE SuperCut XE mikrosax | STILLE SuperCut XE Micro Scissors

Fine micro scissors with straight, sharp tips or curved blunt tips. All models with SuperCut blades.



117-A110



117-A111

Model	Tip Type	Blade Shape	Length	Material
117-A110-15	Sharp tips	Straight	15 cm 6"	●
117-A110-18	Sharp tips	Straight	18 cm 7"	●
117-A110-21	Sharp tips	Straight	21 cm 8.25"	●
117-A111-15	Blunt tips	Curved	15 cm 6"	●
117-A111-18	Blunt tips	Curved	18 cm 7"	●
117-A111-21	Blunt tips	Curved	21 cm 8.25"	●

Plastic  
Orthopaedic  
Popular Model



### STILLE SuperCut XE mikrokärlsax | STILLE SuperCut XE Micro Vascular Scissors

SuperCut XE micro scissors available in five different blade angles for fine vascular surgery. Blade length 11 mm.

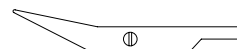

117-A120-25

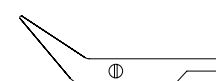

117-A120-45

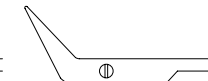

117-A120-60

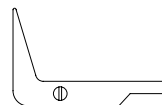

117-A120-90

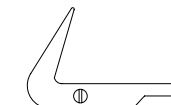

117-A120-125

117-A120-25	Angled 25°	18 cm 7"
117-A120-45	Angled 45°	18 cm 7"
117-A120-60	Angled 60°	18 cm 7"
117-A120-90	Angled 90°	18 cm 7"
117-A120-125	Angled 125°	18 cm 7"

Plastic  
Orthopaedic  
Popular Model



## STILLE SuperCut XE mikrokärlsax | STILLE SuperCut XE Micro Vascular Scissors

Extra fine blade version of STILLE SuperCut XE vascular micro scissors.  
Blade length 7.5 mm.

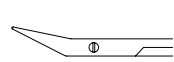

117-A125-25

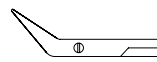

117-A125-45

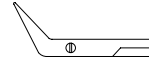

117-A125-60

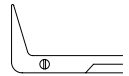

117-A125-90

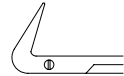

117-A125-125

117-A125-25	Angled 25°	18 cm 7"	<b>NEW</b>
117-A125-45	Angled 45°	18 cm 7"	<b>NEW</b>
117-A125-60	Angled 60°	18 cm 7"	<b>NEW</b>
117-A125-90	Angled 90°	18 cm 7"	<b>NEW</b>
117-A125-125	Angled 125°	18 cm 7"	<b>NEW</b>

Plastic  
Orthopaedic  
Popular Model



### STILLE mikropincett | STILLE Micro Forceps

Well balanced and ergonomic micro forceps of ultra high quality. With tying platform and straight or curved jaws.

117-B110	117-B111				
117-B110-15	Straight	15 cm 6"	●	Plastic	Orthopaedic Popular Model
117-B110-18	Straight	18 cm 7"	●		
117-B110-21	Straight	21 cm 8.25"	●		
117-B111-15	Curved	15 cm 6"	●		
117-B111-18	Curved	18 cm 7"	●		
117-B111-21	Curved	21 cm 8.25"	●		



### STILLE mikropincett | STILLE Micro Forceps

Same fine micro forceps, with Diamond Jaws, for increased tip durability and secure grip of fine needles.

117-B120	117-B121				
117-B120-15	Diamond Jaws	Straight	15 cm 6"	●	Plastic Orthopaedic Popular Model
117-B120-18	Diamond Jaws	Straight	18 cm 7"	●	
117-B120-21	Diamond Jaws	Straight	21 cm 8.25"	●	
117-B121-15	Diamond Jaws	Curved	15 cm 6"	●	
117-B121-18	Diamond Jaws	Curved	18 cm 7"	●	
117-B121-21	Diamond Jaws	Curved	21 cm 8.25"	●	



### STILLE mikropincett | STILLE Micro Forceps

Micro forceps with Diamond Jaws and Counter-balance.

117-B130	117-B131				
117-B130-18	Diamond Jaws	Straight	18 cm 7"	●	Plastic Orthopaedic Popular Model
117-B130-21	Diamond Jaws	Straight	21 cm 8.25"	●	
117-B131-18	Diamond Jaws	Curved	18 cm 7"	●	
117-B131-21	Diamond Jaws	Curved	21 cm 8.25"	●	



### STILLE mikro ringpincett | STILLE Micro Ring Forceps

Counter-balanced micro forceps with fine Diamond Jaws ring tips.



117-B140

117-B140-18	1.0x0.5 mm	Diamond Jaws	Straight	18 cm 7"
117-B140-21	1.0x0.5 mm	Diamond Jaws	Straight	21 cm 8.25"

Plastic  
Orthopaedic  
Popular Model



### STILLE mikro klopincett | STILLE Micro Tissue Forceps

Fine micro forceps with 1x2 teeth.

117-B150-15	1x2 fine teeth	Straight	15 cm 6"	NEW	●
117-B150-18	1x2 fine teeth	Straight	18 cm 7"	NEW	●
117-B150-21	1x2 fine teeth	Straight	21 cm 8.25"	NEW	●

Plastic  
Orthopaedic  
Popular Model



### STILLE mikro nålförare | STILLE Micro Needle Holder

Well balanced and ergonomic micro needle holder. Round handles facilitate finger tip control. Available with straight or curved jaws. All models with Diamond Jaws.



Model	Jaws	Configuration	Length	Material
117-C110-15	Diamond Jaws	Straight	15 cm 6"	● Plastic
117-C110-18	Diamond Jaws	Straight	18 cm 7"	● Orthopaedic
117-C110-21	Diamond Jaws	Straight	21 cm 8.25"	● Popular Model
117-C110-23	Diamond Jaws	Straight	23 cm 9"	● NEW
117-C111-15	Diamond Jaws	Curved	15 cm 6"	● Plastic
117-C111-18	Diamond Jaws	Curved	18 cm 7"	● Orthopaedic
117-C111-21	Diamond Jaws	Curved	21 cm 8.25"	● Popular Model
117-C111-23	Diamond Jaws	Curved	23 cm 9"	● NEW



### STILLE mikro nålförare | STILLE Micro Needle Holder

Same fine micro needle holder, with lock.

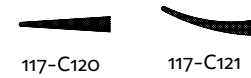

Model	Jaws	Configuration	Length	Material
117-C120-15	Diamond Jaws	Straight	15 cm 6"	● Plastic
117-C120-18	Diamond Jaws	Straight	18 cm 7"	● Orthopaedic
117-C120-21	Diamond Jaws	Straight	21 cm 8.25"	● Popular Model
117-C120-23	Diamond Jaws	Straight	23 cm 9"	● NEW
117-C121-15	Diamond Jaws	Curved	15 cm 6"	● Plastic
117-C121-18	Diamond Jaws	Curved	18 cm 7"	● Orthopaedic
117-C121-21	Diamond Jaws	Curved	21 cm 8.25"	● Popular Model
117-C121-23	Diamond Jaws	Curved	23 cm 9"	● NEW





## STILLE mikro nålförare | STILLE Micro Needle Holder

Extra heavy model for handling of larger needles with TC-inserts. Intended for 2/0 suture and finer.



117-C130  
117-C140

117-C130-19	TC-inserts	Without lock	19 cm 7.5"	NEW	●	Plastic
117-C130-23	TC-inserts	Without lock	23 cm 9"	NEW		Orthopaedic
117-C130-25	TC-inserts	Without lock	25 cm 9.75"	NEW		Popular Model
117-C140-19	TC-inserts	With lock	19 cm 7.5"	NEW	●	
117-C140-23	TC-inserts	With lock	23 cm 9"	NEW		
117-C140-25	TC-inserts	With lock	25 cm 9.75"	NEW		



**STILLE ERBJUDER** ett antal övriga instrument som komplement till huvudsortimentet. Här finns exempelvis unika produkter som STILLES artroskopikanyler, STILLE Hemostop och instrumentvårdsprodukter. Här kan man också hitta vårt utvalda sortiment av ortopediska implantat av högsta kvalitet, där Palmerstift, Wibergmärlor och Kirschner trådborrar ingår.



**STILLE OFFERS** a number of various instruments as a complement to the main offering. Included here are among other products, STILLE Arthroset, STILLE Hemostop and instrument care products. In this section we also offer a selected range of top quality orthopaedic implants, such as our well-known Palmer bone nails, Wiberg fracture staples and Kirschner wire drills.

Övriga instrument | Various instruments | Sonstige  
Instrumente | Altri strumenti | Instrumentos varios |  
様々な器具

Ergonomic design ensures  
comfortable grip and exact  
handling of delicate tissue.

All instruments are manufactured in  
selected top quality surgical steel.

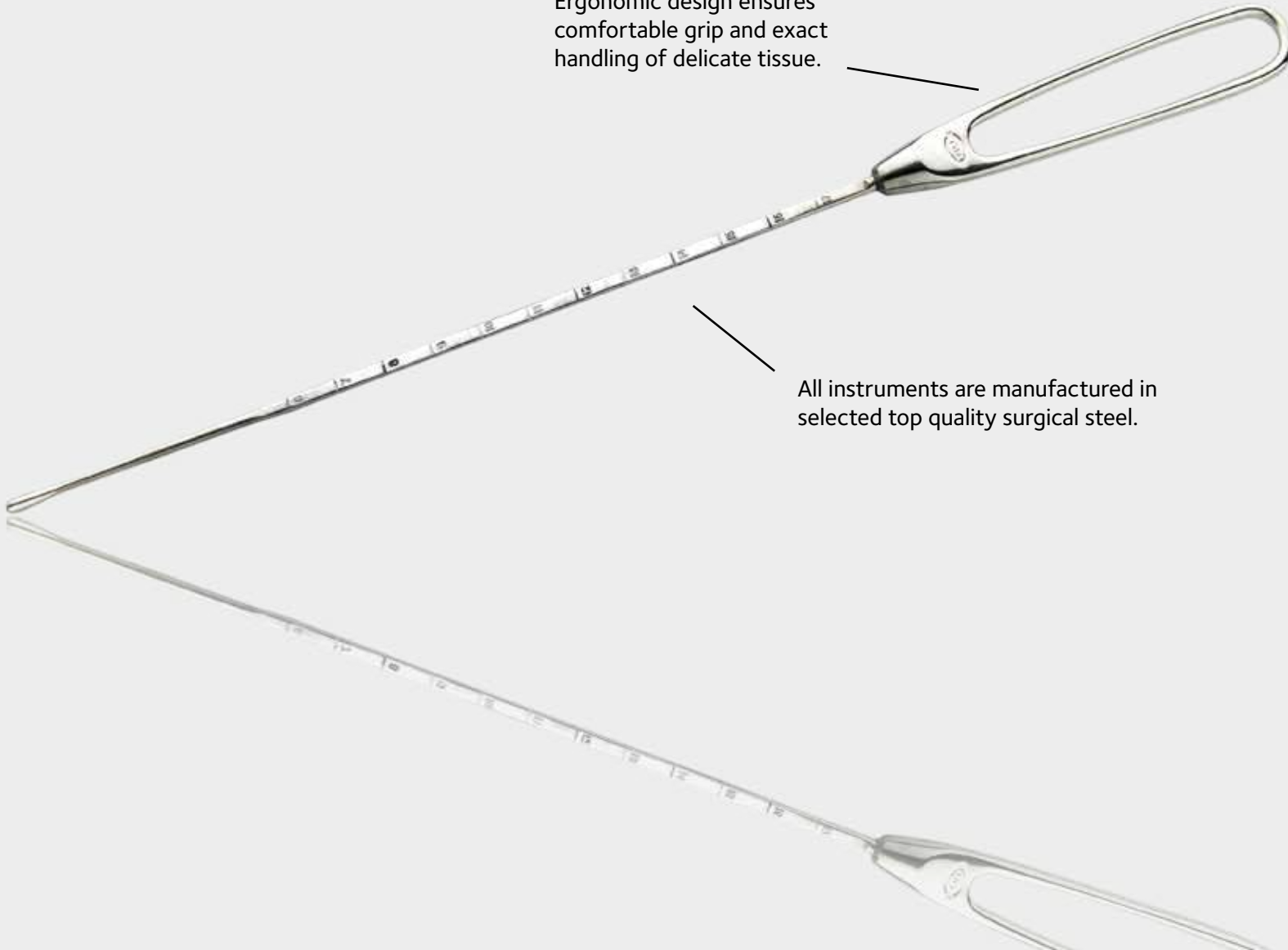



### Gillquist-STILLE artroskopisugrör | Gillquist-STILLE Arthroscopy Suction Tube

Arthroscopy suction tube with mandrin.

119-10915	28 cm 11"	Plastic Orthopaedic Popular Model
-----------	-----------	---

### Oretorp-STILLE sond | Oretorp-STILLE Probe

Blunt ended probe for arthroscopy. Graduated shaft.



119-10928	Blunt	19.5 cm 7.75"	Plastic Orthopaedic Popular Model
-----------	-------	---------------	---

### STILLE sond | STILLE Probe

Blunt ended probe for arthroscopy. Graduated shaft.



119-10928-1	Blunt	19.5 cm 7.75"	Plastic Orthopaedic Popular Model
-------------	-------	---------------	---

### STILLE uterusond | STILLE Uterine Sound

Uterine sound with malleable silver shaft. Graduated in cm.  
Drop-shaped tip.



119-28452 27 cm 10.75"

Plastic  
Orthopaedic  
Popular Model

### Bergström-STILLE muskelbiopsi kanyl | Bergström-STILLE Muscle biopsy Cannula

Muscle biopsy cannula. Consists of a sharptipped, hollow outer needle with a small opening near the tip. A punch with a sharp edge fits tightly into the needle. The stylet is used for pushing out biopsy specimens from the punch.



119-29187-50 Diam 5 mm

119-29187-60 Diam 6 mm

Plastic  
Orthopaedic  
Popular Model

### STILLE Jameson skjutmått | STILLE Jameson Caliper

Caliper graduated 0-80 mm.

119-30025	0-80 mm 0-3"	9.5 cm 3.75"	<b>NEW</b>	<ul style="list-style-type: none"> <li>Plastic</li> <li>Orthopaedic</li> <li>Popular Model</li> </ul>
-----------	--------------	--------------	------------	---



### STILLE Castroviejo skjutmått | STILLE Castroviejo Caliper

Caliper with locking screw, graduated 0-20 mm.

119-30022	0-20 mm	8 cm 3.1"	<b>NEW</b>	<ul style="list-style-type: none"> <li>Plastic</li> <li>Orthopaedic</li> <li>Popular Model</li> </ul>
-----------	---------	-----------	------------	---

### STILLE mätsticka | STILLE Ruler

Stainless steel ruler graduated in mm, 0-15 cm.

119-30010-15	15 cm 6"	<b>NEW</b>	<ul style="list-style-type: none"> <li>Plastic</li> <li>Orthopaedic</li> <li>Popular Model</li> </ul>
--------------	----------	------------	---



Regarding new products, please see [www.stille.se](http://www.stille.se) for latest update. Product images to be added in next printed edition.

### STILLE Freeman areolamarkör | STILLE Freeman Areola Marker

Areola marker in three different sizes.

			Plastic	Orthopaedic	Popular Model
119-30042-38	38 mm	NEW	●		
119-30042-42	42 mm	NEW	●		
119-30042-45	45 mm	NEW	●		



### STILLE Julian areolamarkör | STILLE Julian Areola Marker

A set of 4 areola markers.

			Plastic	Orthopaedic	Popular Model
119-30045	Set 40, 44, 48, 52 mm	NEW	●		



### McKissock STILLE areolamått | McKissock STILLE Areola Caliper

Keyhole pattern marker in three different sizes.

			Plastic	Orthopaedic	Popular Model
119-30048-38	38 mm	NEW	●		
119-30048-42	42 mm	NEW	●		
119-30048-45	45 mm	NEW	●		

Regarding new products, please see [www.stille.se](http://www.stille.se) for latest update. Product images to be added in next printed edition.



### STILLE skalpellhandtag | STILLE Scalpel Handle

The most common scalpel handles made with highest precision.

					Plastic	Orthopaedic	Popular Model
119-50010-3	No 3	Blade 10-15	12 cm 5"	<b>NEW</b>	●	●	●
119-50010-13	No 3L	Blade 10-15	21 cm 8.25"	<b>NEW</b>	●	●	
119-50010-4	No 4	Blade 18-25	13 cm 5.25"	<b>NEW</b>	●	●	●
119-50010-14	No 4L	Blade 18-25	21 cm 8.25"	<b>NEW</b>	●	●	
119-50010-7	No 7	Blade 10-15	16 cm 6.25"	<b>NEW</b>	●	●	



### STILLE Barron skalpellhandtag | STILLE Barron Scalpel Handle

8-sided handle for precise handling and rotation.

					Plastic	Orthopaedic	Popular Model
119-50012	Blade 10-15	14 cm 5,5"	<b>NEW</b>	●			

### STILLE skalpellhandtag | STILLE Scalpel Handle

Round handle guarantees precise finger tip control.

					Plastic	Orthopaedic	Popular Model
119-50015	Blade 10-15	14.5 cm 5.75"	<b>NEW</b>	●			





### STILLE Mayo peanghängare | STILLE Mayo Safety Pin

Safety Pin with ball for better control of instruments on the tray.

119-50022 13.5 cm 5.25" **NEW**

Plastic  
Orthopaedic  
Popular Model

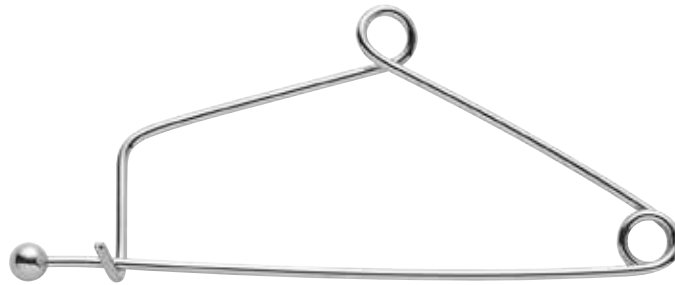

### STILLE Hemostop | STILLE Hemostop

Designed as an aid to stemming complicated venous and arterial bleeding during open surgery. Relatively long to be able to reach down into the pelvis.

119-60001 Ring diameter 18/28 mm 24 cm 9.5"

Plastic  
Orthopaedic  
Popular Model





### STILLE instrumentolja | STILLE Instrument Oil

Instrument oil, package of 2 pcs á 50 ml.

119-78900-1	50 ml, package of 2 pcs	Plastic	Orthopaedic	Popular Model
-------------	-------------------------	---------	-------------	---------------

### STILLE rengöringsborste | STILLE Cleaning Brush

Cleaning brush for surgical instruments. Special stainless steel fine threaded, bristle diameter 0.12 mm, height 20 mm. Handy grip of plastic material. Autoclavable at 121C.

119-78950	20 cm 8", package 2 pcs	Plastic	Orthopaedic	Popular Model
-----------	-------------------------	---------	-------------	---------------



### STILLE Instrumentbricka | STILLE Instrument Sterilization Tray

Instrument tray for transport, sterilization and storage of delicate instruments. The trays are designed to assure proper penetration of sterilizing agent between the mat and the tray surface. Silicone mat included. Available in three different sizes. The trays are made to withstand common sterilization methods, including steam, gas, cold sterilization solutions, and temperatures up to 182°C/360 F.

199-60010	Micro tray	10.1x19x1.9 cm	4x7.5x0.75"	Plastic	Orthopaedic	Popular Model
199-60020	Micro tray	15.2x25.4x1.9 cm	6x10x0.75"	Plastic	Orthopaedic	Popular Model
199-60030	Instrument tray	25.4x38.1x1.9 cm	10x15x0.75"	Plastic	Orthopaedic	Popular Model

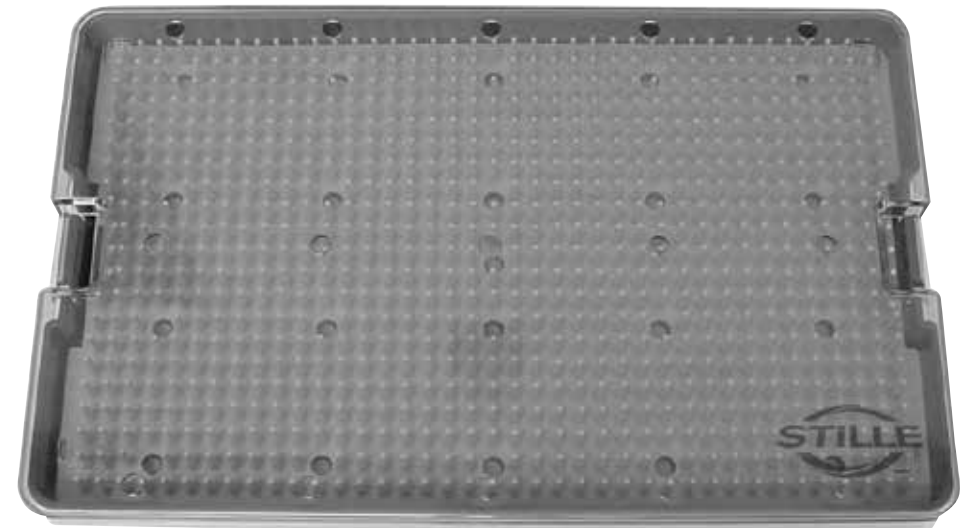

## STILLE-Gigli trådsåg | STILLE-Gigli Wire Saw

Gigli wire saw with superior cutting quality. Smooth joints between loops and wire. Available in three different lengths.

			Plastic	Orthopaedic	Popular Model
125-19150-30	Pack of 25 pcs	30 cm 12"	●	●	
125-19150-40	Pack of 25 pcs	40 cm 15.75"	●	●	
125-19150-50	Pack of 25 pcs	50 cm 20"	●		
125-19160	Handle	6.5 cm 2.5"		●	
125-19170	Guide/Dura Protector	34 cm 13"		●	



125-19160

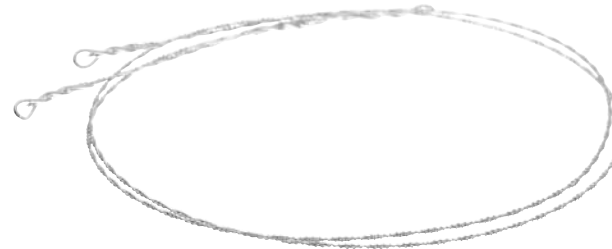

125-19150-40



125-19170

## STILLE artroskopikanylset | STILLE Arthroscopy Cannula Set

STILLE Arthroscopy cannula set is designed for maximal outflow through same diameter in inner diameter, drainage holes, connection and tubing - no interruptions. As an extra benefit a connector is added in all packages, offering the possibility to use it for intraarticular injection of saline before operating. Tubing 195 cm. Carton of 4 x 20 pcs, length 95 mm.

				Plastic	Orthopaedic	Popular Model
415-2020	Sterile	ID 2.5 mm	OD 4.0 mm	●	●	
415-2025-400	Sterile	ID 4.0 mm	OD 5.4 mm	●	●	



## STILLE gipssåg | STILLE Plaster Cast Remover

A complete kit of plaster cast removers including wire saws in two lengths, stainless steel handles and plastic profiles.

				Plastic	Orthopaedic	Popular Model
413-2500-2	Metal Handle			●		
413-2502-85	Wire Saws	100 pcs	85 cm 33.5"	●	●	
413-2502-125	Wire Saws	100 pcs	125 cm 49.25"	●	●	
413-2504-85	Soft Profiles	100 pcs	85 cm 33.5"	●	●	
413-2504-125	Soft Profiles	100 pcs	125 cm 49.25"	●	●	



## STILLE frakturtråd | STILLE Bone Wire

STILLE bone wire on 5 m coils.

				Plastic	Orthopaedic	Popular Model
121-18013-4	Stainless	0.4 mm	5 m coils diam ,soft	●	●	
121-18013-5	Stainless	0.5 mm	5 m coils diam, soft	●	●	
121-18013-6	Stainless	0.6 mm	5 m coils diam, soft	●	●	
121-18013-7	Stainless	0.7 mm	5 m coils diam, soft	●	●	
121-18013-8	Stainless	0.8 mm	5 m coils diam, soft	●	●	
121-18013-9	Stainless	0.9 mm	5 m coils diam, soft	●	●	
121-18013-10	Stainless	1.0 mm	5 m coils diam, soft	●	●	



## Palmer-STILLE benstift | Palmer-STILLE Bone Nail

Round bone nails with diameter 1.5 mm.

				Plastic	Orthopaedic	Popular Model
121-18224-15	Stainless	Round	Length 15 mm	●	●	
121-18224-20	Stainless	Round	Length 20 mm	●	●	
121-18224-25	Stainless	Round	Length 25 mm	●	●	
121-18224-30	Stainless	Round	Length 30 mm	●	●	
121-18224-35	Stainless	Round	Length 35 mm	●	●	
121-18224-40	Stainless	Round	Length 40 mm	●	●	
121-18224-45	Stainless	Round	Length 45 mm	●	●	
121-18224-50	Stainless	Round	Length 50 mm	●	●	
121-18224-55	Stainless	Round	Length 55 mm	●	●	
121-18224-60	Stainless	Round	Length 60 mm	●	●	
121-18224-65	Stainless	Round	Length 65 mm	●	●	
121-18224-70	Stainless	Round	Length 70 mm	●	●	
121-18227	Holder/Driver		12 cm 5.7"	●		
121-18229	Impactor		17 cm 6.75"	●		





### Wiberg-STILLE benmärla | Wiberg-STILLE Fracture Staple

Fracture staples in three different sizes.

			Plastic	Orthopaedic	Popular Model
121-18251-16	Stainless	16 mm	●	●	
121-18251-19	Stainless	19 mm	●	●	
121-18251-22	Stainless	22 mm	●	●	
121-18255	Holder/Driver	17 cm 6.75"	●		

### STILLE Kirschner trådborr | STILLE Kirschner Wire Drill

Wire drills with lancet points with or without eye.

					Plastic	Orthopaedic	Popular Model
121-19357-11	Without eye	1.1 mm	23.5 cm 9.25"		●	●	
121-19357-13	Without eye	1.3 mm	23.5 cm 9.25"		●	●	
121-19357-15	Without eye	1.5 mm	23.5 cm 9.25"		●	●	
121-19357-18	Without eye	1.8 mm	23.5 cm 9.25"		●	●	
121-19357-20	Without eye	2.0 mm	23.5 cm 9.25"		●	●	
121-19357-213	With eye	1.3 mm	23.5 cm 9.25"		●	●	
121-19357-215	With eye	1.5 mm	23.5 cm 9.25"		●	●	
121-19357-218	With eye	1.8 mm	23.5 cm 9.25"		●	●	
121-19357-220	With eye	2.0 mm	23.5 cm 9.25"		●	●	





**DR. HERBERT OLIVECRONA**, professor i neurokirurgi vid Karolinska institutet, pionjär inom neurokirurgi vid Serafimerlasarettet, läkare vid Sabbatsbergs sjukhus samt ledamot av Kungliga Vetenskapsakademien. Utvecklade flera instrument tillsammans med STILLE, såsom kyretter, peanger och pincetter.

**DR. HERBERT OLIVECRONA**, professor of neurosurgery at the Karolinska Institute, a pioneer in neurosurgery at the Serafimer Hospital, doctor at Sabbatsberg Hospital and member of the Royal Swedish Academy of Sciences. Developed several instruments in collaboration with STILLE, such as currettes, artery forceps and forceps.



# Numeriskt index | Numerical index | Nummernverzeichnis | Indice di numeri | Indice de números | 品番索引

101		Art nr	Page	Art nr	Page	Art nr	Page	Art nr	Page	Art nr	Page	Art nr	Page
		101-8084-15	20	101-8166-	31	101-8201-45	33	101-8586-9	42	102-9244-20	51	103-10028-121	58
<b>Art nr</b>	<b>Page</b>	101-8084-17	20	101-8166-1	31	101-8201-60	33	101-8595-18	42	102-9244-25	51	103-10030-121	58
101-8001	16	101-8084-19	20	101-8166-2	32	101-8201-90	33	101-8597-14	43	102-9248-15	48	103-10032-121	58
101-8002	16	101-8085-15	21	101-8167	31	101-8378	26	101-8604	37	102-9248-20	48	103-10032-181	58
101-8003	16	101-8085-17	21	101-8167-1	31	101-8380-12	26	101-8815-12	43	102-9248-25	48	103-10035-121	58
101-8004	16	101-8085-19	21	101-8167-151	31	101-8380-121	26			102-9252-20	48	103-10037-121	58
101-8010	16	101-8086-15	20	101-8167-152	32	101-8380-122	27			102-9252-25	48	103-10115-141	59
101-8010-1	16	101-8086-17	20	101-8167-181	31	101-8380-15	26			102-9252-30	48	103-10117-141	59
101-8011	16	101-8086-19	20	101-8167-182	32	101-8380-151	26			102-9254	50	103-10150-141	59
101-8011-1	16	101-8087-15	21	101-8167-2	32	101-8380-152	27	102-9019	46	102-9255-20	50	103-10152-141	59
101-8015	16	101-8087-17	21	101-8170-1	31	101-8380-18	26	102-9020	49	102-9255-25	50	103-10160-161	60
101-8015-1	16	101-8087-19	21	101-8171-1	31	101-8380-181	26	102-9020-1	49	102-9270-20	48	103-10162-161	60
101-8016	16	101-8090	21	101-8172-18	23	101-8380-20	26	102-9020-15	49	102-9300	53	103-10172	60
101-8016-1	16	101-8092	21	101-8172-23	23	101-8380-201	26	102-9021	46	102-9302	53	103-10180-141	61
101-8018-1	17	101-8096-20	28	101-8173-15	24	101-8380-23	26	102-9021-1	46	102-9304	53	103-10180-161	61
101-8019-1	17	101-8096-23	28	101-8173-18	24	101-8380-231	26	102-9022	46	102-9308	53	103-10180-181	61
101-8019-2	17	101-8097-20	29	101-8173-20	24	101-8411	36	102-9022-15	46	102-9312	53	103-10182-141	61
101-8020	18	101-8097-23	29	101-8174-15	24	101-8417	36	102-9023-12	46	102-9314	53	103-10182-161	61
101-8021	18	101-8098-20	28	101-8174-18	24	101-8420	29	102-9024	49	102-9316	53	103-10182-181	61
101-8021-1	18	101-8098-23	28	101-8174-20	24	101-8425	37	102-9025	49	102-9318	53	103-10185	61
101-8022	18	101-8098-30	28	101-8174-23	24	101-8430-171	38	102-9025-1	49	102-9320	53	103-10185-161	61
101-8025	34	101-8099-20	29	101-8174-26	24	101-8430-172	38	102-9027	46	102-9322	53	103-10187-141	61
101-8031-1	17	101-8099-23	29	101-8175-15	25	101-8431-171	38	102-9028	47	102-9330	53	103-10187-161	61
101-8031-2	17	101-8099-30	29	101-8175-152	25	101-8431-172	38	102-9030-13	49	102-9340	53	103-10190	62
101-8042-15	28	101-8100-15	21	101-8175-18	25	101-8433-20	38	102-9030-15	49	102-9342	53	103-10192	62
101-8043-15	28	101-8102-15	21	101-8175-182	25	101-8433-202	38	102-9030-17	49	102-9354	53	103-10195	62
101-8047-13	28	101-8110	34	101-8175-20	25	101-8435-20	38	102-9030-20	49	102-9460	52	103-10197	62
101-8047-15	28	101-8110-1	34	101-8175-23	25	101-8435-202	38	102-9030-25	49	102-9470	52	103-10200-161	62
101-8048-15	28	101-8115	34	101-8175-26	25	101-8436-20	38	102-9040-15	49	102-9845-15	54	103-10200-181	62
101-8048-18	28	101-8115-1	34	101-8175-30	25	101-8440-201	39	102-9040-17	49	102-9845-20	54	103-10202-161	62
101-8060	18	101-8120	35	101-8175-33	25	101-8441-201	39	102-9040-20	49	102-9845-25	54	103-10202-181	62
101-8060-1	19	101-8120-1	35	101-8176-15	25	101-8442-171	39	102-9040-25	49	102-9846-20	55	103-10205-161	63
101-8060-2	19	101-8122	35	101-8176-18	25	101-8452	39	102-9040-30	49	102-9852-20	54	103-10205-181	63
101-8062	18	101-8123	35	101-8176-20	25	101-8456-171	40	102-9050-13	47	102-9852-25	54	103-10207-161	63
101-8062-1	19	101-8123-1	35	101-8176-23	25	101-8458-17	40	102-9060-15	47	102-9852-30	54	103-10207-181	63
101-8062-2	19	101-8125	35	101-8176-26	25	101-8458-172	40	102-9060-17	47	102-9855-20	54	103-10210-201	63
101-8080-15	19	101-8138	22	101-8200-125	33	101-8458-20	40	102-9060-20	47	102-9855-25	54	103-10210-241	63
101-8080-17	19	101-8160	22	101-8200-25	33	101-8458-202	40	102-9062-15	47			103-10212-201	63
101-8081-15	20	101-8161	22	101-8200-45	33	101-8459-20	40	102-9062-17	47			103-10212-241	63
101-8082-15	19	101-8162	22	101-8200-60	33	101-8460	30	102-9062-20	47			103-10212-301	63
101-8082-17	19	101-8163	22	101-8200-90	33	101-8470	27	102-9077-20	50			103-10215-201	64
101-8083-15	20	101-8163-2	23	101-8201-125	33	101-8580	30	102-9078-20	50			103-10215-241	64
		101-8164	41	101-8201-25	33	101-8584	42	102-9244-15	51			103-10217-201	64
										<b>103</b>			
										103-10015-131	58		
										103-10026-121	58		



<b>Art nr</b>	<b>Page</b>
111-22150	158
111-22155-10	158
111-22155-13	158
111-22155-19	158
111-22155-25	158
111-22158-9	159
111-22160	159
111-22171-12	160
111-22171-4	160
111-22171-7	160
111-22171-9	160
111-22350	160
111-22370	161
111-22385-4	161
111-22440-18	167
111-22440-24	167
111-22442-19	167
111-22442-24	167
111-22444	167
111-22446	167
111-22520-4	162
111-22522-4	163
111-22532	164
111-22550-10	164
111-22550-8	164
111-22563-3	166
111-22563-6	166
111-22565-6	165
111-22565-8	165
111-22567-9	165
111-22568-18	165
111-22569-18	165
111-22569-24	165
111-22635	166
111-22860	168
111-22861	168
111-22862	168
111-22863	168
111-22870	168
111-22871	168
111-22873	168
<b>117</b>	
117-A110-15	188
117-A110-18	188
117-A110-21	188
117-A111-15	188
117-A111-18	188
117-A111-21	188
117-A120-125	188
117-A120-25	188
117-A120-45	188
117-A120-60	188
117-A120-90	188
117-A125-125	189

<b>Art nr</b>	<b>Page</b>
117-A125-25	189
117-A125-45	189
117-A125-60	189
117-A125-90	189
117-B110-15	190
117-B110-18	190
117-B110-21	190
117-B111-15	190
117-B111-18	190
117-B111-21	190
117-B120-15	190
117-B120-18	190
117-B120-21	190
117-B121-15	190
117-B121-18	190
117-B121-21	190
117-B130-18	190
117-B130-21	190
117-B131-18	190
117-B131-21	190
117-B140-18	191
117-B140-21	191
117-B150-15	191
117-B150-18	191
117-B150-21	191
117-C110-15	192
117-C110-18	192
117-C110-21	192
117-C110-23	192
117-C111-15	192
117-C111-18	192
117-C111-21	192
117-C111-23	192
117-C120-15	192
117-C120-18	192
117-C120-21	192
117-C120-23	192
117-C121-15	192
117-C121-18	192
117-C121-21	192
117-C121-23	192
117-C130-19	193
117-C130-23	193
117-C130-25	193
117-C140-19	193
117-C140-23	193
117-C140-25	193
<b>119</b>	
119-10915	196
119-10928	196
119-10928-1	196
119-28452	197
119-29187-50	197
119-29187-60	197

<b>Art nr</b>	<b>Page</b>
119-30010-15	198
119-30022	198
119-30025	198
119-30042-38	199
119-30042-42	199
119-30042-45	199
119-30045	199
119-30048-38	199
119-30048-42	199
119-30048-45	199
119-50010-13	200
119-50010-13	200
119-50010-3	200
119-50010-4	200
119-50010-7	200
119-50012	200
119-50015	200
119-50022	201
119-60001	201
119-78900-1	202
119-78950	202
<b>121</b>	
121-18013-10	205
121-18013-4	205
121-18013-5	205
121-18013-6	205
121-18013-7	205
121-18013-8	205
121-18013-9	205
121-18224-15	205
121-18224-20	205
121-18224-25	205
121-18224-30	205
121-18224-35	205
121-18224-40	205
121-18224-45	205
121-18224-50	205
121-18224-55	205
121-18224-60	205
121-18224-65	205
121-18224-70	205
121-18227	205
121-18229	205
121-18251-16	206
121-18251-19	206
121-18251-22	206
121-18255	206
121-19357-11	206
121-19357-13	206
121-19357-15	206
121-19357-18	206
121-19357-20	206
121-19357-213	206
121-19357-215	206

<b>Art nr</b>	<b>Page</b>
121-19357-218	206
121-19357-220	206
<b>125</b>	
125-19150-30	203
125-19150-40	203
125-19150-50	203
125-19160	203
125-19170	203
<b>199</b>	
199-60010	202
199-60020	202
199-60030	202
<b>413</b>	
413-2500-2	204
413-2502-125	204
413-2502-85	204
413-2504-125	204
413-2504-85	204
<b>415</b>	
415-2020	204
415-2025-400	204



**DR. CLARENCE CRAFOORD**, professor i thoraxkirurgi vid Karolinska institutet samt överläkare vid Sabbatsbergs sjukhus. En pionjär inom thoraxkirurgi som genomförde världens första operation av kärlmissbildning vid medfött hjärtfel. Utvecklade tillsammans med STILLE, bland annat pincetter och peanger som än idag bär hans namn.

**DR. CLARENCE CRAFOORD**, professor of thoracic surgery at the Karolinska Institute and Chief Physician at Sabbatsberg Hospital. A pioneer in thoracic surgery who conducted the world's first operation for vascular malformation of congenital heart defects. Developed in collaboration with STILLE forceps and artery forceps, which still bear his name.

# Alfabetiskt register

## A

Produktnamn	Sida
Adlercreutz STILLE pincett	48
Adson STILLE anatomisk pincett	49
Adson STILLE peang	65
Adson STILLE pincett	46
Adson STILLE självhållande hake	150
Adson-Brown STILLE pincett	46
Adson-Callison STILLE pincett	46
Allis STILLE fattningstång	125, 126
Alm STILLE hake	149
Aston STILLE SuperCut XE Face-lift sax	39
Aufricht STILLE glabellarasp	168
Aufricht STILLE nashake	140

## B

Babcock STILLE fattningstång	124
Baby Mayo STILLE dissektionssax	21
Baby Metzenbaum STILLE dissektionssax	22
Baby Metzenbaum STILLE SuperCut XE dissektionssax	22
Baby Metzenbaum STILLE SuperCut XE ergonomisk dissektionssax	23
Backhaus STILLE dukklämmare	123
Bengolea STILLE peang	64
Bergström-STILLE muskelbiopsi kanyl	197
Beyer STILLE gougetång	92, 93
Björk-STILLE diatermipincetter	54
Björk-STILLE knutpincett	55
Blad till Finochietto STILLE revbensspridare	151
Boyd-STILLE tonsillsax	29

## C

Carlens STILLE Tracheotomihake	148
Caspar STILLE bittång	107
Christophe-STILLE peang	60
Cinelli STILLE osteotom	177
Cobb STILLE raspatorium	158
Converse STILLE nålförare	83
Converse STILLE nashake	141
Cottle STILLE nässpekulum	152
Cottle STILLE osteotom	178
Cottle STILLE raspatorium	159
Cottle STILLE septumlevatorium	164
Crafoord STILLE peang	69
Crafoord-STILLE anatomisk pincett	50

Produktnamn	Sida
Crile STILLE peang	61
Crile STILLE peang	61
Crile-Wood STILLE gracil nålförare	79
Cushing STILLE bittång	105

## D

Dandy STILLE peang	66
Davis STILLE SuperCut XE Face-lift sax	39
Deaver STILLE hake	141
Derf STILLE nålförare	75
Desmarres STILLE ögonlockshake	143
Doyen STILLE bukshake	145
Duval STILLE fattningstång	124

## E

Ericsson-STILLE carotisklämmare	121
Ericsson-STILLE profunda arteria femoralis klämmare	122

## F

Finochietto STILLE revbensspridare	151
Foerster STILLE ringtång	128
Fomon STILLE nässax	34
Fomon STILLE rasp	168
Freeman STILLE Facelift hake	144
Freeman STILLE hake	144
Freer STILLE elevatorium	163

## G

Gillies STILLE hudhake	134
Gillies STILLE nålförare	76
Gillies STILLE pincett	46
Gillquist-STILLE artroskopisugrör	196
Gorney STILLE SuperCut XE ergonomisk Face-lift sax	38
Gorney STILLE SuperCut XE Face-lift sax	38

## H

Halsey STILLE nålförare	77
Halsted-Mosquito STILLE gracil peang	58
Halsted-Mosquito STILLE peang	58
Heiss STILLE peang	68

Produktnamn	Sida
Hohmann STILLE elevatorium	165
Howarth STILLE näsraspatorium	161
Håkansson STILLE gougetång	92

## J

Jabaley STILLE dissektionssax	18
Jabaley STILLE SuperCut XE dissektionssax	19
Jabaley STILLE SuperCut XE ergonomisk dissektionssax	19
Joseph STILLE hudhake	134
Joseph STILLE nässax	34
Joseph STILLE raspatorium	161
Joseph STILLE SuperCut XE nässax	34
Julian STILLE Facelift hake	142
Julian STILLE nashake	143

## K

Kaye STILLE dissektionssax	18
Kaye STILLE nålförare	82
Kaye STILLE SuperCut XE dissektionssax	18
Kelly STILLE peang	59
Kelly-Rankin STILLE peang	60
Kerrison STILLE laminektomistans	103,104
Kilner STILLE nålförare	75
Kleinert-Kutz STILLE hudhake	135
Kocher STILLE bukspatel	147
Kocher STILLE peang	59
König-STILLE nageluppklipningsax	30

## L

Lambert-Kay STILLE aorta anastomosklämmare	119
Lambotte STILLE miniosteotom	175
Lambotte STILLE osteotom	174
Lambotte STILLE raspatorium	159
Langenbeck STILLE elevatorium	164
Langenbeck STILLE hake	139
Leksell STILLE gougetång	97
Leksell STILLE gougetång	98
Leriche STILLE peang	62
Lexer STILLE osteotom	176
Lister STILLE TC bandagesax	42
Littauer STILLE sutursax	43
Littler STILLE trådföringsax	41
Love STILLE nervhake	136
Love-Gruenwald STILLE bittång	105

Produktnamn	Sida
Luer-STILLE gougetång	95

## M

Maier STILLE tvättång	127
Matarasso STILLE SuperCut XE ergonomisk Face-lift sax	40
Matarasso STILLE SuperCut XE Face-lift sax	40
Mathieu STILLE nålförare	82
Mayo STILLE dissektionssax	19
Mayo STILLE SuperCut XE dissektionssax	20
Mayo-Harrington STILLE operationsax	28
Mayo-Harrington STILLE SuperCut XE operationsax	29
Mayo-Hegar STILLE nålförare	77
Mayo-Hegar STILLE kraftig nålförare	78
Mayo-Noble STILLE dissektionssax	21
McIndoe STILLE anatomisk pincett	49
McKissock STILLE areolamarkör	199
Metzenbaum STILLE gracil dissektionssax	23
Metzenbaum STILLE dissektionssax	24
Metzenbaum STILLE gracil SuperCut XE dissektionssax	24
Metzenbaum STILLE SuperCut XE dissektionssax	25
Metzenbaum STILLE SuperCut XE ergonomisk dissektionssax	25
Millard STILLE tumringshake	140
Mini-Hohmann STILLE elevatorium	165
Moberg STILLE hake	137

## N

Neivert STILLE osteotom	177
New Orleans STILLE nålförare	79

## O

Olivecrona STILLE peang	65
Olivecrona STILLE raspatorium	158
Olivecrona-STILLE durapincett	51
Olsen-Hegar STILLE nålförare	81
Oretorp-STILLE sond	196
Overholt STILLE peang	68

## P

Produktnamn	Sida
Palmer-STILLE benstift	205
Parkes STILLE gougemejsel	180
Pean STILLE peang	58
Peck-Joseph STILLE nåssax	35
Peck-Joseph STILLE SuperCut XE nåssax	35
Peet STILLE nåsrasp	168
Perman STILLE bukhake	146

## R

Ragnell STILLE dissektionssax	26
Ragnell STILLE hake	139
Ragnell STILLE operationssax	30
Ragnell STILLE raspatorium	160
Ragnell STILLE SuperCut XE dissektionssax	26
Ragnell STILLE SuperCut XE ergonomisk dissektionssax	27
Ragnell STILLE SuperCut XE ergonomisk ögonlockssax	17
Ragnell STILLE SuperCut XE ögonlockssax	17
Rapp-STILLE knuthållartång	84
Récamier STILLE uteruskyrett	156
Rees STILLE SuperCut XE Face-lift sax	40
Rochester-Ochsner STILLE peang	63, 64
Rochester-Péan STILLE peang	62, 63
Ruskin-STILLE gougetång	94
Russian STILLE pincett	48
Ryder STILLE nålförare	80

## S

Satinsky STILLE tangential occlusionsklämmare	116
Sawtell STILLE peang	67
Schmidt STILLE peang	66
Schroeder STILLE klotång	129
Semb STILLE behållartång	100
Senn STILLE hake	140
Sims STILLE dissektionssax	22
Spencer STILLE sutursax	42
Spurling STILLE bittång	106
Stevens-STILLE SuperCut XE ergonomisk tenotomisax	32
Stevens-STILLE SuperCut XE tenotomisax	31
Stevens-STILLE tenotomisax	31
STILLE anastomosklämmare	118
STILLE anatomisk pincett	49
STILLE artroskopikanylset	204
STILLE artär- och ligaturklämmare	70
STILLE Barron skalpellhandtag	200
STILLE benavbitare	90, 91
STILLE brösthake	142
STILLE Caplan SuperCut XE nåssax	36
STILLE Castroviejo skjutmått	198
STILLE colonklämmare	110
STILLE Cooper operationssax	28

Produktnamn	Sida
STILLE Cottle SuperCut XE nåssax	37
STILLE Crile-Wood nålförare	78
STILLE DeBakey aorta aneurysmklämmare	120
STILLE DeBakey kärpincett	53
STILLE dissektor	167
STILLE-Ehrén ligaturklämma	70
STILLE elevatorium	166
STILLE extraktionstång	89
STILLE Fomon SuperCut XE nåssax	37
STILLE frakturtråd	205
STILLE Freeman areolamarkör	199
STILLE-Gigli trådsåg	203
STILLE gipssåg	204
STILLE gougemejsel	180
STILLE gougetång	94, 96, 99
STILLE hake	138
STILLE hammare	182, 183
STILLE handosteotom	176
STILLE Hemostop	201
STILLE Instrumentbricka	202
STILLE instrumentolja	202
STILLE irispincett	52
STILLE Jameson skjutmått	198
STILLE Julian areolamarkör	199
STILLE Kirschner trådborr	206
STILLE-Mayo dissektionssax	20
STILLE Mayo peanghängare	201
STILLE-Mayo SuperCut XE dissektionssax	21
STILLE McKissock areolamarkör	199
STILLE mejsel	179
STILLE mikro klopincett	191
STILLE mikro nålförare	192, 193
STILLE mikro ringpincett	191
STILLE mikropincett	190
STILLE mini tangential occlusionsklämmare	115
STILLE mini universalklämmare	112
STILLE mätsticka	198
STILLE nervhake	136
STILLE nålförare	80, 81
STILLE näselevatorium	163
STILLE nåsraspatorium	162
STILLE osteotom	172, 173
STILLE perifer kärklämmare	117
STILLE pincett	47
STILLE plattång	88
STILLE pryl	181
STILLE rengöringsborste	202
STILLE skalpellhandtag	200
STILLE slev	157
STILLE sond	196
STILLE ståltrådsroterare	85
STILLE SuperCut XE kärlsax	33
STILLE SuperCut XE mikrokärlsax	188, 189
STILLE SuperCut XE mikrosax	188
STILLE SuperCut XE nåssax	36
STILLE SuperCut XE ögonlockssax	17

Produktnamn	Sida
STILLE SuperCut XE ögonsax	16
STILLE sutursax	42
STILLE tråдавbitare	101, 102
STILLE universalklämmare	113, 114
STILLE uterusmanipulator	130
STILLE uterussond	197
STILLE ögonsax	16
Stolte STILLE tonsillelevatorium	166
Strandell STILLE hake	137

## T

Produktnamn	Sida
Thorek STILLE dissektionssax	27

## U

Universal STILLE ståltrådsax	43
Uppsala STILLE galltång	111

## V

Vienna STILLE nässpekulum	152
Volkman STILLE hake	138

## W

Waugh-Brophy STILLE anatomisk pincett	50
Waugh-Brophy STILLE isolerad diatermipincett	54
Waugh-Brophy STILLE pincett	48
Webster STILLE nålförare	75, 76
Webster/Kleinert STILLE nålförare	76
Weitlaner STILLE hake	149
Wiberg STILLE raspatorium	160
Wiberg-STILLE benmärkla	206
Wikström STILLE galltång	111

## Z

Zaufal-Jansen STILLE gougetång	93
--------------------------------	----

# Alphabetical index | Alphabetisches Inhaltsverzeichnis | Indice alfabetico | Índice alfabético | アルファベット索引

## A

Product	Page
Adlercreutz STILLE Tissue Forceps	48
Adson STILLE Dressing Forceps	49
Adson STILLE Artery Forceps	65
Adson STILLE Tissue Forceps	46
Adson STILLE Self Retaining Retractor	150
Adson-Brown STILLE Tissue Forceps	46
Allis STILLE Intestinal Grasping Forceps	125, 126
Alm STILLE Retractor	149
Aston STILLE SuperCut XE Face-lift scissors	39
Aufricht STILLE Glabella Rasp	168
Aufricht STILLE Nasal Retractor	140

## B

Babcock STILLE Intestinal Grasping Forceps	124
Baby Mayo STILLE Dissecting Scissors	21
Baby Metzenbaum STILLE Dissecting Scissors	22
Baby Metzenbaum STILLE SuperCut XE Dissecting Scissors	22
Baby Metzenbaum STILLE SuperCut XE Ergonomic Dissecting Scissors	23
Backhaus STILLE Towel Clamps	123
Bengolea STILLE Artery Forceps	64
Bergström-STILLE Muscle biopsy Cannula	197
Beyer STILLE Bone Rongeur	92
Beyer STILLE Bone Rongeur	93
Björk-STILLE Diathermy Forceps	54
Björk-STILLE Knot-Holding Forceps	55
Blades to Finochietto STILLE Rib Spreader	151
Boyd-STILLE Tonsil Scissors	29

## C

Carlens STILLE Trachea Retractor	148
Caspar STILLE Rongeur	107
Christophe-STILLE Artery Forceps	60
Cinelli STILLE Osteotome	177
Cobb STILLE Raspatory	158
Converse STILLE Needle holder	83
Converse STILLE Nasal Retractor	141
Cottle STILLE Nasal Speculum	152
Cottle STILLE Osteotome	178
Cottle STILLE Raspatory	159

Product	Page
Cottle STILLE Septum Elevator	164
Crafoord STILLE Artery Forceps	69
Crafoord-STILLE Dressing Forceps	50
Crile STILLE Artery Forceps	61
Crile-Wood STILLE Delicate Needle holder	79
Cushing STILLE Rongeur	105

## D

Dandy STILLE Artery Forceps	66
Davis STILLE SuperCut XE Face-lift Scissors	39
Deaver STILLE Retractor	141
Derf STILLE Needle holder	75
Desmarres STILLE Eye-lid Retractor	143
Doyen STILLE Abdominal Retractor	145
Duval STILLE Intestinal Grasping Forceps	124

## E

Ericsson-STILLE Carotid Clamp	121
Ericsson-STILLE Profunda Femoral Artery Clamps	122

## F

Finochietto STILLE Rib Spreader	151
Foerster STILLE Sponge Holding Forceps	128
Fomon STILLE Nasal Scissors	34
Fomon STILLE Rasp	168
Freeman STILLE Facelift Retractor	144
Freeman STILLE Retractor	144
Freer STILLE Elevator	163

## G

Gillies STILLE Skin Hook	134
Gillies STILLE Needle Holder	76
Gillies STILLE Tissue Forceps	46
Gillquist-STILLE Arthroscopy Suction Tube	196
Gorney STILLE SuperCut XE Ergonomic Face-lift scissors	38
Gorney STILLE SuperCut XE Face-lift scissors	38

## H

Product	Page
Halsey STILLE Needle Holder	77
Halsted-Mosquito STILLE delicate Artery Forceps	58
Halsted-Mosquito STILLE Artery Forceps	58
Heiss STILLE Artery Forceps	68
Hohmann STILLE Elevator	165
Howarth STILLE Nasal Raspatory	161
Håkansson STILLE Bone Rongeur	92

## J

Jabaley STILLE Dissecting Scissors	18
Jabaley STILLE SuperCut XE Dissecting Scissors	19
Jabaley STILLE SuperCut XE Ergonomic Dissecting Scissors	19
Joseph STILLE Skin Hook	134
Joseph STILLE Nasal Scissors	34
Joseph STILLE Raspatory	161
Joseph STILLE SuperCut XE Nasal Scissors	34
Julian STILLE Facelift Retractor	142
Julian STILLE Nasal Retractor	143

## K

Kaye STILLE Dissecting Scissors	18
Kaye STILLE Needle holder	82
Kaye STILLE SuperCut XE Dissecting Scissors	18
Kelly STILLE Artery Forceps	59
Kelly-Rankin STILLE Artery Forceps	60
Kerrison STILLE Laminectomy Punch	103, 104
Kilner STILLE Needle holder	75
Kleinert-Kutz STILLE Skin Hook	135
Kocher STILLE Abdominal Spatula	147
Kocher STILLE Artery Forceps	59
König-STILLE Nail-splitting Scissors	30

## L

Lambert-Kay STILLE Aortic-Anastomosis Clamp	119
Lambotte STILLE Mini Osteotome	175
Lambotte STILLE Osteotome	174
Lambotte STILLE Raspatory	159
Langenbeck STILLE Elevator	164

Product	Page
Langenbeck STILLE Retractor	139
Leksell STILLE Bone Rongeur	97
Leksell STILLE Bone Rongeur	98
Leriche STILLE Artery Forceps	62
Lexer STILLE Osteotome	176
Lister STILLE TC Bandage Scissors	42
Littauer STILLE Suture scissors	43
Littler STILLE Suture carrying scissors	41
Love STILLE Nerve Hook	136
Love-Gruenwald STILLE Rongeur	105
Luer-STILLE Bone Rongeur	95

## M

Maier STILLE Sponge Holding Forceps	127
Matarasso STILLE SuperCut XE Ergonomic Face-lift scissors	40
Matarasso STILLE SuperCut XE Face-lift scissors	40
Mathieu STILLE Needle holder	82
Mayo STILLE Dissecting Scissors	19
Mayo STILLE SuperCut XE Dissecting Scissors	20
Mayo-Harrington STILLE Operating Scissors	28
Mayo-Harrington STILLE SuperCut XE Operating Scissors	29
Mayo-Hegar STILLE Needle holder	77
Mayo-Hegar STILLE Heavy Needle holder	78
Mayo-Noble STILLE Dissecting Scissors	21
McIndoe STILLE Dressing Forceps	49
McKissock STILLE Areola Marker	199
Metzenbaum STILLE Delicate Dissecting Scissors	23
Metzenbaum STILLE Dissecting Scissors	24
Metzenbaum STILLE Delicate SuperCut XE Dissecting Scissors	24
Metzenbaum STILLE SuperCut XE Dissecting Scissors	25
Metzenbaum STILLE SuperCut XE Ergonomic Dissecting Scissors	25
Millard STILLE Thumb Ring Retractor	140
Mini-Hohmann STILLE Elevator	165
Moberg STILLE Retractor	137

## N

Neivert STILLE Osteotome	177
New Orleans STILLE Needle holder	79

## O

Product	Page
Olivecrona STILLE Artery Forceps	65
Olivecrona STILLE Raspatory	158
Olivecrona-STILLE Dura Forceps	51
Olsen-Hegar STILLE Needle holder	81
Oretorp-STILLE Probe	196
Overholt STILLE Dissecting Forceps	68

## P

Palmer-STILLE Bone Nail	205
Parkes STILLE Hump Gouge	180
Pean STILLE Artery Forceps	58
Peck-Joseph STILLE Nasal Scissors	35
Peck-Joseph STILLE SuperCut XE Nasal Scissors	35
Peet STILLE Nasal Rasp	168
Perman STILLE Abdominal Retractor	146

## R

Ragnell STILLE Dissecting Scissors	26
Ragnell STILLE Retractor	139
Ragnell STILLE Operating Scissors	30
Ragnell STILLE Raspatory	160
Ragnell STILLE SuperCut XE Dissecting Scissors	26
Ragnell STILLE SuperCut XE Ergonomic Dissecting Scissors	27
Ragnell STILLE SuperCut XE Ergonomic Blepharoplasty Scissors	17
Ragnell STILLE SuperCut XE Blepharoplasty Scissors	17
Rapp-STILLE Knot-holding Forceps	84
Récamier STILLE Uterine curette	156
Rees STILLE SuperCut XE Face-lift scissors	40
Rochester-Ochsner STILLE Artery Forceps	63
Rochester-Péan STILLE Artery Forceps	62, 63
Ruskin-STILLE Bone Rongeur	94
Russian STILLE Tissue Forceps	48
Ryder STILLE Needle holder	80

## S

Satinsky STILLE Tangential Occlusion Clamp	116
Sawtell STILLE Artery Forceps	67
Schmidt STILLE Artery Forceps	66
Schroeder STILLE Tenaculum Forceps	129
Semb STILLE Bone Holding Forceps	100
Senn STILLE Retractor	140
Sims STILLE Dissecting Scissors	22
Spencer STILLE Suture scissors	42
Spurling STILLE Rongeur	106
Stevens-STILLE SuperCut XE Ergonomic Tenotomy Scissors	32
Stevens-STILLE SuperCut XE Tenotomy Scissors	31
Stevens-STILLE Tenotomy Scissors	31

Product	Page
STILLE Anastomosis Clamp	118
STILLE Dressing Forceps	49
STILLE Arthroscopy Cannula Set	204
STILLE Artery and Ligature Clamp	70
STILLE Barron Scalpel Handle	200
STILLE Bone Cutting Forceps	90, 91
STILLE Breast Retractor	142
STILLE Caplan SuperCut XE Nasal Scissors	36
STILLE Castroviejo Caliper	198
STILLE Colon Clamp	110
STILLE Cooper Operating Scissors	28
STILLE-Ehrén Ligature Clamp	70
Satinsky STILLE Tangential Occlusion Clamp	116
Sawtell STILLE Artery Forceps	67
Schmidt STILLE Artery Forceps	66
Schroeder STILLE Tenaculum Forceps	129
Semb STILLE Bone Holding Forceps	100
Senn STILLE Retractor	140
Sims STILLE Dissecting Scissors	22
Spencer STILLE Suture scissors	42
Spurling STILLE Rongeur	106
Stevens-STILLE SuperCut XE Ergonomic Tenotomy Scissors	32
Stevens-STILLE SuperCut XE Tenotomy Scissors	31
Stevens-STILLE Tenotomy Scissors	31
STILLE Anastomosis Clamp	118
STILLE Artery and Ligature Clamp	70
STILLE Arthroscopy Cannula Set	204
STILLE Awl	181
STILLE Barron Scalpel Handle	200
STILLE Bone curette	157
STILLE Bone Cutting Forceps	90, 91
STILLE Bone Rongeur	94, 96, 99
STILLE Bone Wire	205
STILLE Breast Retractor	142
STILLE Caplan SuperCut XE Nasal Scissors	36
STILLE Castroviejo Caliper	198
STILLE Chisel	179
STILLE Colon Clamp	110
STILLE Cooper Operating Scissors	28
STILLE Cottle SuperCut XE Nasal Scissors	37
STILLE Cleaning Brush	202
STILLE Crile-Wood Needle holder	78
STILLE DeBakey Aortic-Aneurysm Clamp	120
STILLE DeBakey Vascular Forceps	53
STILLE Dissector	167
STILLE Dressing Forceps	49
STILLE Elevator	166
STILLE Extraction plier	89
STILLE Eye Scissors	16
STILLE Flat pliers	88
STILLE Fomon SuperCut XE Nasal Scissors	37
STILLE Freeman Areola Marker	199
STILLE-Gigli Wire Saw	203
STILLE Gouge	180
STILLE Hand Osteotome	176
STILLE Hemostop	201

Product	Page
STILLE Instrument Oil	202
STILLE Instrument Sterilization Tray	202
STILLE Iris Forceps	52
STILLE Jameson Caliper	198
STILLE Julian Areola Marker	199
STILLE Kirschner Wire Drill	206
STILLE Mallet	182, 183
STILLE-Mayo Dissecting Scissors	20
STILLE Mayo Safety Pin	201
STILLE-Mayo SuperCut XE Dissecting Scissors	21
STILLE Micro Forceps	190
STILLE Micro Needle Holder	192, 193
STILLE Micro Ring Forceps	191
STILLE Micro Tissue Forceps	191
STILLE mini Multi-purpose clamp	112
STILLE mini Tangential Occlusion Clamp	115
STILLE Multi-purpose clamp	113, 114
STILLE Nasal Elevator	163
STILLE Nasal Raspatory	162
STILLE Needle holder	80, 81
STILLE Nerve Hook	136
STILLE Osteotome	172, 173
STILLE Peripheral Vascular Clamp	117
STILLE Plaster Cast Remover	204
STILLE Probe	196
STILLE Retractor	138
STILLE Ruler	198
STILLE Scalpel Handle	200
STILLE SuperCut XE Blepharoplasty Scissors	17
STILLE SuperCut XE Eye Scissors	16
STILLE SuperCut XE Micro Scissors	188
STILLE SuperCut XE Micro Vascular Scissors	188, 189
STILLE SuperCut XE Nasal Scissors	36
STILLE SuperCut XE Vascular Scissors	33
STILLE Suture scissors	42
STILLE Tissue Forceps	47
STILLE Uterine Manipulator	130
STILLE Uterine Sound	197
STILLE Wire Cutter	101, 102
STILLE Wire Twisting Forceps	85
Stolte STILLE Tonsil Elevator	166
Strandell STILLE Retractor	137

## T

Thorek STILLE Dissecting Scissors	27
-----------------------------------	----

## U

Universal STILLE Wire Cutting scissors	43
Uppsala STILLE Gall Duct Clamp	111

## V

Vienna STILLE Nasal Speculum	152
Volkman STILLE Retractor	138

## W

Product	Page
Waugh-Brophy STILLE Dressing Forceps	50
Waugh-Brophy STILLE insulated Diathermy Forceps	54
Waugh-Brophy STILLE Tissue Forceps	48
Webster STILLE Needle holder	75, 76
Webster/Kleinert STILLE Needle holder	76
Weitlaner STILLE Retractor	149
Wiberg STILLE Raspatory	160
Wiberg-STILLE Fracture Staple	206
Wikström STILLE Gall Duct Clamp	111

## Z

Zaufal-Jansen STILLE Bone Rongeur	93
-----------------------------------	----



# Plastikkirurgi | Plastic & reconstructive surgery | Plastische & Wiederherstellungschirurgie | Chirurgia plastica & ricostruttiva | Cirugía plástica & reconstructiva | 形成外科

<b>A</b>		<b>Product</b>	<b>Page</b>	<b>Product</b>	<b>Page</b>	<b>M</b>	
<b>Product</b>	<b>Page</b>					<b>Product</b>	<b>Page</b>
Adson STILLE Dressing Forceps	49	Cottle STILLE Raspatory	159	Halsted-Mosquito STILLE Artery Forceps	58	Maier STILLE Sponge Holding Forceps	127
Adson STILLE Artery Forceps	65	Cottle STILLE Septum Elevator	164	Howarth STILLE Nasal Raspatory	161	Matarasso STILLE SuperCut XE Ergonomic Face-lift scissors	40
Adson STILLE Tissue Forceps	46	Crafoord-STILLE Dressing Forceps	50			Matarasso STILLE SuperCut XE Face-lift scissors	40
Adson-Brown STILLE Tissue Forceps	46	Crile STILLE Artery Forceps	61	<b>J</b>		Mayo STILLE Dissecting Scissors	19
Adson-Callison STILLE Tissue Forceps	46	Crile-Wood STILLE Delicate Needle holder	79	Jabaley STILLE Dissecting Scissors	18	Mayo STILLE SuperCut XE Dissecting Scissors	20
Allis STILLE Intestinal Grasping Forceps	125, 126			Jabaley STILLE SuperCut XE Ergonomic Dissecting Scissors	19	Mayo-Hegar STILLE Needle holder	77
Alm STILLE Retractor	149	<b>D</b>		Joseph STILLE Skin Hook	134	Mayo-Hegar STILLE Heavy Needle holder	78
Aston STILLE SuperCut XE Face-lift scissors	39	Dandy STILLE Artery Forceps	66	Joseph STILLE Nasal Scissors	34	McIndoe STILLE Dressing Forceps	49
Aufricht STILLE Glabella Rasp	168	Davis STILLE SuperCut XE Face-lift Scissors	39	Joseph STILLE Raspatory	161	McKissock STILLE Areola Marker	199
Aufricht STILLE Nasal Retractor	140	Deaver STILLE Retractor	141	Joseph STILLE SuperCut XE Nasal Scissors	34	Metzenbaum STILLE Delicate Dissecting Scissors	23
		Derf STILLE Needle holder	75	Julian STILLE Facelift Retractor	142	Metzenbaum STILLE Dissecting Scissors	24
		Desmarres STILLE Eye-lid Retractor	143	Julian STILLE Nasal Retractor	143	Metzenbaum STILLE Delicate SuperCut XE Dissecting Scissors	24
<b>B</b>				<b>K</b>		Metzenbaum STILLE SuperCut XE Dissecting Scissors	25
Baby Mayo STILLE Dissecting Scissors	21	<b>F</b>		Kaye STILLE Dissecting Scissors	18	Metzenbaum STILLE SuperCut XE Ergonomic Dissecting Scissors	25
Baby Metzenbaum STILLE Dissecting Scissors	22	Foerster STILLE Sponge Holding Forceps	128	Kaye STILLE Needle holder	82	Millard STILLE Thumb Ring Retractor	140
Baby Metzenbaum STILLE SuperCut XE Dissecting Scissors	22	Fomon STILLE Nasal Scissors	34	Kaye STILLE SuperCut XE Dissecting Scissors	18	Moberg STILLE Retractor	137
Baby Metzenbaum STILLE SuperCut XE Ergonomic Dissecting Scissors	23	Fomon STILLE Rasp	168	Kelly STILLE Artery Forceps	59		
Backhaus STILLE Towel Clamps	123	Freeman STILLE Facelift Retractor	144	Kelly-Rankin STILLE Artery Forceps	60	<b>N</b>	
Bengolea STILLE Artery Forceps	64	Freeman STILLE Retractor	144	Kilner STILLE Needle holder	75	Neivert STILLE Osteotome	177
Beyer STILLE Bone Rongeur	92	Freer STILLE Elevator	163	Kleinert-Kutz STILLE Skin Hook	135	New Orleans STILLE Needle holder	79
Beyer STILLE Bone Rongeur	93			Kocher STILLE Artery Forceps	59		
Björk-STILLE Diathermy Forceps	54	<b>G</b>		<b>L</b>		<b>O</b>	
Björk-STILLE Knot-Holding Forceps	55	Gillies STILLE Skin Hook	134	Lambotte STILLE Mini Osteotome	175	Olivecrona STILLE Artery Forceps	65
		Gillies STILLE Needle Holder	76	Langenbeck STILLE Retractor	139	Olsen-Hegar STILLE Needle holder	81
		Gillies STILLE Tissue Forceps	46	Leriche STILLE Artery Forceps	62	Overholt STILLE Dissecting Forceps	68
		Gorney STILLE SuperCut XE Ergonomic Face-lift scissors	38	Lister STILLE TC Bandage Scissors	42		
		Gorney STILLE SuperCut XE Face-lift scissors	38	Littauer STILLE Suture scissors	43		
<b>C</b>				Littler STILLE Suture carrying scissors	41		
Christophe-STILLE Artery Forceps	60	<b>H</b>		Love STILLE Nerve Hook	136		
Cinelli STILLE Osteotome	177	Halsey STILLE Needle Holder	77				
Converse STILLE Needle holder	83	Halsted-Mosquito STILLE delicate Artery Forceps	58				
Converse STILLE Nasal Retractor	141						
Cottle STILLE Nasal Speculum	152						
Cottle STILLE Osteotome	178						

## P

Product	Page
Parke STILLE Hump Gouge	180
Pean STILLE Artery Forceps	58
Peck-Joseph STILLE Nasal Scissors	35
Peck-Joseph STILLE SuperCut XE Nasal Scissors	35
Peet STILLE Nasal Rasp	168

## R

Ragnell STILLE Dissecting Scissors	26
Ragnell STILLE Retractor	139
Ragnell STILLE Operating Scissors	30
Ragnell STILLE Raspatory	160
Ragnell STILLE SuperCut XE Dissecting Scissors	26
Ragnell STILLE SuperCut XE Ergonomic Dissecting Scissors	27
Ragnell STILLE SuperCut XE Ergonomic Blepharoplasty Scissors	17
Ragnell STILLE SuperCut XE Blepharoplasty Scissors	17
Rapp-STILLE Knot-holding Forceps	84
Rees STILLE SuperCut XE Face-lift scissors	40
Rochester-Ochsner STILLE Artery Forceps	63, 64
Rochester-Péan STILLE Artery Forceps	62, 63
Ryder STILLE Needle holder	80

## S

Sawtell STILLE Artery Forceps	67
Schmidt STILLE Artery Forceps	66
Senn STILLE Retractor	140
Spencer STILLE Suture scissors	42
Stevens-STILLE SuperCut XE Ergonomic Tenotomy Scissors	32
Stevens-STILLE SuperCut XE Tenotomy Scissors	31
Stevens-STILLE Tenotomy Scissors	31
STILLE Artery and Ligature Clamp	70
STILLE Barron Scalpel Handle	200
STILLE Bone curette	157
STILLE Bone Cutting Forceps	90, 91
STILLE Breast Retractor	142
STILLE Caplan SuperCut XE Nasal Scissors	36
STILLE Castroviejo Caliper	198
STILLE Cleaning Brush	202
STILLE Cooper Operating Scissors	28
STILLE Cottle SuperCut XE Nasal Scissors	37
STILLE Crile-Wood Needle holder	78
STILLE Dressing Forceps	49
STILLE Eye Scissors	16
STILLE Fomon SuperCut XE Nasal Scissors	37
STILLE Freeman Areola Marker	199
STILLE Gouge	180
STILLE Hand Osteotome	176
STILLE Instrument Oil	202
STILLE Instrument Sterilization Tray	202

Product	Page
STILLE Iris Forceps	52
STILLE Jameson Caliper	198
STILLE Julian Areola Marker	199
STILLE Mallet	182, 183
STILLE Mayo Safety Pin	201
STILLE-Mayo Dissecting Scissors	20
STILLE-Mayo SuperCut XE Dissecting Scissors	21
STILLE Micro Forceps	190
STILLE Micro Needle Holder	192, 193
STILLE Micro Tissue Forceps	191
STILLE Nasal Elevator	163
STILLE Nasal Raspatory	162
STILLE Needle holder	80
STILLE Needle holder	81
STILLE Osteotome	172
STILLE Retractor	138
STILLE Ruler	198
STILLE Scalpel Handle	200
STILLE SuperCut XE Blepharoplasty Scissors	17
STILLE SuperCut XE Eye Scissors	16
STILLE SuperCut XE Micro Scissors	188
STILLE SuperCut XE Nasal Scissors	36
STILLE Suture scissors	42
STILLE Tissue Forceps	47
Stolte STILLE Tonsil Elevator	166
Strandell STILLE Retractor	137

## V

Vienna STILLE Nasal Speculum	152
Volkman STILLE Retractor	138

## W

Waugh-Brophy STILLE Dressing Forceps	50
Waugh-Brophy STILLE insulated Diathermy Forceps	54
Waugh-Brophy STILLE Tissue Forceps	48
Webster STILLE Needle holder	75, 76
Webster/Kleinert STILLE Needle holder	76
Weitlaner STILLE Retractor	149
Wiberg STILLE Raspatory	160

## Z

Zaufal-Jansen STILLE Bone Rongeur	93
-----------------------------------	----

# Ortopedi | Orthopaedic surgery | Orthopädie | Chirurgia ortopedica | Cirugía ortopédica | 整形外科

## A

Product	Page
Adlercreutz STILLE Tissue Forceps	48
Adson STILLE Dressing Forceps	49
Adson STILLE Artery Forceps	65
Adson STILLE Tissue Forceps	46
Adson STILLE Self Retaining Retractor	150
Adson-Brown STILLE Tissue Forceps	46
Allis STILLE Intestinal Grasping Forceps	125, 126

## B

Baby Mayo STILLE Dissecting Scissors	21
Baby Metzenbaum STILLE Dissecting Scissors	22
Baby Metzenbaum STILLE SuperCut XE Dissecting Scissors	22
Baby Metzenbaum STILLE SuperCut XE Ergonomic Dissecting Scissors	23
Backhaus STILLE Towel Clamps	123
Bengolea STILLE Artery Forceps	64
Beyer STILLE Bone Rongeur	92
Beyer STILLE Bone Rongeur	93
Björk-STILLE Diathermy Forceps	54
Björk-STILLE Knot-Holding Forceps	55

## C

Christophe-STILLE Artery Forceps	60
Cobb STILLE Raspatory	158
Cottle STILLE Osteotome	178
Cottle STILLE Raspatory	159
Crafoord-STILLE Dressing Forceps	50
Crile STILLE Artery Forceps	61
Crile-Wood STILLE Delicate Needle holder	79

## D

Dandy STILLE Artery Forceps	66
Deaver STILLE Retractor	141
Derf STILLE Needle holder	75

## F

Foerster STILLE Sponge Holding Forceps	128
--	-----

## G

Product	Page
Gillies STILLE Tissue Forceps	46
Gillquist-STILLE Arthroscopy Suction Tube	196

## H

Halsey STILLE Needle Holder	77
Halsted-Mosquito STILLE Artery Forceps	58
Hohmann STILLE Elevator	165
Howarth STILLE Nasal Raspatory	161
Håkansson STILLE Bone Rongeur	92

## J

Jabaley STILLE Dissecting Scissors	18
Jabaley STILLE SuperCut XE Dissecting Scissors	19
Joseph STILLE Raspatory	161

## K

Kelly STILLE Artery Forceps	59
Kelly-Rankin STILLE Artery Forceps	60
Kocher STILLE Artery Forceps	59

## L

Lambotte STILLE Mini Osteotome	175
Lambotte STILLE Osteotome	174
Lambotte STILLE Raspatory	159
Langenbeck STILLE Elevator	164
Langenbeck STILLE Retractor	139
Leksell STILLE Bone Rongeur	97
Leksell STILLE Bone Rongeur	98
Lexer STILLE Osteotome	176
Lister STILLE TC Bandage Scissors	42
Littauer STILLE Suture scissors	43
Luer-STILLE Bone Rongeur	95

## M

Maier STILLE Sponge Holding Forceps	127
Mathieu STILLE Needle holder	82
Mayo STILLE Dissecting Scissors	19

## Product

Product	Page
Mayo STILLE SuperCut XE Dissecting Scissors	20
Mayo-Harrington STILLE Operating Scissors	28
Mayo-Harrington STILLE SuperCut XE Operating Scissors	29
Mayo-Hegar STILLE Needle holder	77
Mayo-Hegar STILLE Heavy Needle holder	78
Mayo-Noble STILLE Dissecting Scissors	21
McIndoe STILLE Dressing Forceps	49
McKissock STILLE Areola Marker	199
Metzenbaum STILLE Delicate Dissecting Scissors	23
Metzenbaum STILLE Dissecting Scissors	24
Metzenbaum STILLE Delicate SuperCut XE Dissecting Scissors	24
Metzenbaum STILLE SuperCut XE Dissecting Scissors	25
Metzenbaum STILLE SuperCut XE Ergonomic Dissecting Scissors	25
Mini-Hohmann STILLE Elevator	165
Moberg STILLE Retractor	137

## N

New Orleans STILLE Needle holder	79
----------------------------------	----

## O

Olivecrona STILLE Artery Forceps	65
Olivecrona STILLE Raspatory	158
Olsen-Hegar STILLE Needle holder	81
Olsen-Hegar STILLE Needle holder	81
Oretorp-STILLE Probe	196

## P

Palmer-STILLE Bone Nail	205
Pean STILLE Artery Forceps	58

## R

Ragnell STILLE Dissecting Scissors	26
Ragnell STILLE SuperCut XE Dissecting Scissors	26
Ragnell STILLE SuperCut XE Ergonomic Dissecting Scissors	27
Ragnell STILLE SuperCut XE Ergonomic Dissecting Scissors	27
Rapp-STILLE Knot-holding Forceps	84
Rochester-Ochsner STILLE Artery Forceps	63, 64

## Product

Product	Page
Rochester-Péan STILLE Artery Forceps	62, 63
Ruskin-STILLE Bone Rongeur	94
Russian STILLE Tissue Forceps	48

## S

Sawtell STILLE Artery Forceps	67
Schmidt STILLE Artery Forceps	66
Semb STILLE Bone Holding Forceps	100
Spencer STILLE Suture scissors	42
Stevens-STILLE SuperCut XE Ergonomic Tenotomy Scissors	32
Stevens-STILLE SuperCut XE Tenotomy Scissors	31
Stevens-STILLE Tenotomy Scissors	31
STILLE Arthroscopy Cannula Set	204
STILLE Awl	181
STILLE Bone curette	157
STILLE Bone Cutting Forceps	90, 91
STILLE Bone Rongeur	94, 96, 99
STILLE Bone Wire	205
STILLE Chisel	179
STILLE Cleaning Brush	202
STILLE Cooper Operating Scissors	28
STILLE Crile-Wood Needle holder	78
STILLE Dressing Forceps	49
STILLE Elevator	166
STILLE Extraction plier	89
STILLE Flat pliers	88
STILLE-Gigli Wire Saw	203
STILLE Gouge	180
STILLE Hand Osteotome	176
STILLE Instrument Oil	202
STILLE Kirschner Wire Drill	206
STILLE Mallet	182, 183
STILLE-Mayo Dissecting Scissors	20
STILLE Mayo Safety Pin	201
STILLE-Mayo SuperCut XE Dissecting Scissors	21
STILLE Osteotome	172, 173
STILLE Plaster Cast Remover	204
STILLE Probe	196
STILLE Retractor	138
STILLE Scalpel Handle	200
STILLE Suture scissors	42
STILLE Tissue Forceps	47
STILLE Wire Cutter	101
STILLE Wire Cutter	102
STILLE Wire Twisting Forceps	85

<b>Product</b>	<b>Page</b>
Strandell STILLE Retractor	137

## U

Universal STILLE Wire Cutting scissors	43
--	----

## V

Volkman STILLE Retractor	138
--------------------------	-----

## W

Waugh-Brophy STILLE Dressing Forceps	50
Waugh-Brophy STILLE insulated Diathermy Forceps	54
Waugh-Brophy STILLE Tissue Forceps	48
Weitlaner STILLE Retractor	149
Wiberg STILLE Raspatory	160
Wiberg-STILLE Fracture Staple	206

## Z

Zaufal-Jansen STILLE Bone Rongeur	93
-----------------------------------	----

# Garanti | Guarantee | Garantie | Garanzia | Garantie

## Hanteringsanvisningar

Följande råd och skötselansvisningar har framtagits för att ni skall få största möjliga nytta och glädje av samt optimal livslängd på kirurgiska instrument från STILLE. Dessutom är villkoret för STILLES garantiåtagande att instrumentet hanteras och sköts i enlighet med nedan angivna instruktioner.

1. Hantera instrument varsamt, detta gäller instrument i allmänhet och mikroinstrument i synnerhet.
2. Rengör instrumentet manuellt eller maskinellt så fort som möjligt efter användning. Låt ej föroreningar torka in på instrumentet. Rengöring med metoder som innehåller väteperoxid rekommenderas ej på instrument med svartkrom. Dessa kan bli flammiga, dock påverkas inte funktionen.
3. Förvara inte instrument i fuktigt miljö längre än absolut nödvändigt, t.ex. i avvaktan på transport till sterilcentral. Använd endast för ändamålet avsedda lösningar.
4. Låt inte instrument ligga i mekanisk spänning, t.ex. knäppata eller intrasslade i andra instrument. Det föreligger då risk för spänningskorrosion. Instrument med knäppen skall lämnas öppna. Lägg de tyngsta instrumenten underst med de lättare ovanpå. Mikrokirurgiska instrument skall aldrig läggas ovanpå varandra.
5. Vatten och vattenånga för rengöring, desinfektion och autoklivering kan innehålla salter, metaller och mineraler, vilka kan orsaka korrosion och missfärgningar. Kontrollera vattenkvaliteten. Hårt vatten bör mjukgöras. Slutsköljning av instrument med demineraliserat vatten rekommenderas.
6. Följ alltid fabrikantens anvisningar vid användning av diskdesinfektor och diskmedel. Använd ett diskmedel med pH-värde mellan 8–10,5 i korrekt dosering enligt tillverkarens anvisningar. Förvara inte instrumentet under längre tid i lösningen än vad fabrikanten angivit. Skölj, helst med demineraliserat vatten. Torka instrumentet omedelbart.
7. Använd endast för ändamålet avsedda desinfektionslösningar vid manuell rengöring. Var noga med att följa fabrikantens anvisningar vad gäller dosering och tid. Förvara inte instrumentet under längre tid i lösningen än vad fabrikanten angivit. Skölj, helst med demineraliserat vatten. Torka instrumentet omedelbart.
8. Vid användning av ultraljud för rengöring skall instrumentet vara helt täckt med vätska samt vara öppet. Instrument med ytbeläggning skall ej rengöras i ultraljud. Skölj, gärna med demineraliserat vatten. Torka noga. Följ fabrikantens anvisningar.
9. Kontrollera instrument med avseende på föroreningar, repor, missfärgningar, sprickor, korrosion.
10. Kontrollera varje enskilt instruments funktion.
11. Använd endast instrumentborstar. Stålull får aldrig användas.
12. Anolj instrument, på ställen där metall nöter mot metall, efter varje användning. Anoljning görs lämpligen omedelbart före sterilisering. Använd gärna STILLES instrumentolja. Oljan måste ha en flampunkt över 1350C. Använd endast ringa mängd olja på ytor som möts vid funktion (saxskär, boxlås, skruvar, spärrlås). Torka bort överflödiga olja för undvikande av kladdiga instrument samt fettfläckar på autoklaveringsförpackningen.
13. Följ noga fabrikantens anvisningar vid autoklivering. Var noga med att inte packa instrumenten hårt. Instrument skall autoklaveras "öppna" för

att ångan skall kunna nå alla delar av ett instrument.

14. Hetluftssterilisering rekommenderas ej. Hög temperatur påverkar metall-len.
15. Väteperoxidsterilisering rekommenderas ej för svartkromade instrument. Dessa kan bli flammiga, dock påverkas inte funktionen.
16. Nya instrument måste rengöras, inspekteras, anoljas samt steriliseras före första användning.
17. Använd endast professionell reparatör/verkstad för service och reparationer. T.ex. måste Super Cut –saxar slipas på ett speciellt sätt, annars är det lätt att förstöra eggen. Vid felaktigt utförd reparation/ service gäller ej STILLES garantiåtagande!

## Garanti

Med avseende på utförande och material lämnar vi garanti på kirurgiska handinstrument av egen tillverkning. I en period av 30 år efter inköp, ersätter eller reparerar vi kostnadsfritt ett skadat instrument om skadan finnes orsakad av fel i utförande eller material. Normal förslitning omfattas inte av vår garanti. Utfästelsen gäller under förutsättning att instrumentet används för avsett ändamål samt vårdas och lagras korrekt och att skriftlig anmälan görs till STILLE inom 30 dagar från skadetillfället.

## Instrument Care

The following advice and care instructions have been drawn up to achieve the maximum utilization and optimal length of life from STILLE's surgical instruments. In addition, one of the conditions of STILLE's guarantee commitments is that instruments are handled and cared for according to the instructions stated below.

1. Handle instruments carefully. This applies to instruments in general but particularly to micro instruments.
2. Clean instruments manually or by machine as soon as possible after use. Do not allow contaminants to dry on instruments. Cleaning with any method containing hydrogen peroxide is not recommended for black chrome plated instruments (eg SuperCut scissors).
3. If cleaning must be delayed, store the instruments in an appropriate solution. Do not just use water.
4. Do not allow instruments to remain under mechanical stress since this increases the risks for corrosion and damage. Instruments must not be allowed to lie in a disorganized manner. Instruments with ratchets must be left open. The heaviest instruments on the bottom with lighter instruments above. Microsurgical instruments should never be laid on top of each other.
5. Water and steam used for cleaning, disinfection and auto-claving may

contain salts, metals and minerals that can cause corrosion and discoloration. Check the quality of the water; hard water should be softened. Final rinsing of instruments with demineralized water is recommended.

6. Always follow the manufacturer's instructions when using disinfectants and detergents. Use a detergent with a pH-value between 8–10.5 in correct dosage according to the manufacturer's instructions. Do not store the instrument in the solution longer than indicated by the manufacturer. Rinse, preferably with demineralized water. Dry the instrument immediately.
7. Only use disinfection solutions intended for this purpose. Follow the manufacturer's instructions. Rinse, ideally with demineralized water. Dry the instruments.
8. When using ultrasound for cleaning, instruments should be opened and completely covered with cleaning solution. Coated instruments should not be cleaned in ultrasound. Rinse, ideally with demineralized water. Dry carefully. Follow the manufacturer's instructions.
9. Check instruments for contaminants, scratches, discoloration, cracks and corrosion.
10. Check the function of each individual instrument.
11. Use only instrument brushes. Steel wool should never be used.
12. After the cleaning process, lubricate the instruments where metal is in contact with metal. Use preferably STILLE instrument oil. The oil must have a flashpoint above 135 °C. Use only small amounts of oil on surfaces that are in contact during function (scissors edges, box locks, screws). Clean off excess oil to avoid oily instruments and oily stains on autoclave packaging. If a water-soluble lubricant is used instead of instrument oil, the solution should be diluted with demineralized water. Follow the manufacturer's instructions.
13. Follow the manufacturer's instructions for autoclaving. Instruments should be autoclaved open to allow steam to gain access to all parts of the instruments.
14. Hot air sterilisation is not recommended, as high temperature will affect the metal.
15. Hydrogen peroxide sterilisation is not recommended for black chrome plated instruments. These can become stained although function will not be affected.
16. New instruments must be cleaned, inspected, lubricated and sterilised before they are used for the first time.
17. Use only a professional instrument engineer/workshop for service and repairs. For example, Super Cut scissors must be ground in a special way otherwise the edges may be destroyed. If repairs/service are incorrectly carried out, STILLE's guarantee commitments no longer apply!

## Guarantee

Surgical hand instruments manufactured by STILLE carry a guarantee in respect of materials and workmanship. For a period of 30 years after purchase, we will replace or repair a damaged instrument free of charge if the damage is found to have been caused by a defect in materials or workmanship. The guarantee is conditional on the instrument being used for the purpose intended, is cared for and stored correctly and that any claims are made in writing within 30 days of the damage occurring.

## Gebrauchsanweisungen

Die folgenden Ratschläge und Gebrauchsanleitungen haben wir für Sie gemacht, damit Sie den grösstmöglichen Nutzen und Freude, sowie eine optimale Lebensdauer an chirurgische Instrumente von STILLE haben werden. Unsere Garantie ist auch mit der Bedingung verbunden, dass unsere Instrumente nach unseren Instruktionen behandelt und gepflegt werden.

1. Gebrauchen Sie die Instrumente mit Vorsicht, ganz besonders die Mikroinstrumente.
2. Beseitigen Sie den Schmutz, manuell oder maschinell, direkt nach Gebrauch. Lassen Sie den Schmutz nie in das Instrument eintrocknen. Für schwarz verchromte Instrumente (z. B. SuperCut-Scheren) wird eine Reinigung mit Wasserstoffperoxid nicht empfohlen.
3. Lassen Sie die Instrumente nie länger als notwendig in feuchten Zustand liegen, z.B. beim Abwarten auf Transport zur Sterilzentrale. Benützen Sie nur die für das Instrument bestimmten Desinfektionsmittel.
4. Lassen Sie die Instrumente nicht in mechanischer Spannung, z.B. zusammengespannt oder mit anderen Instrumenten durcheinander liegen. Es kann sonst zu Spannungskorrosion kommen. Legen Sie die schwersten Instrumente nach unten und die leichteren oben drauf. Mikrochirurgische Instrumente dürfen niemals aufeinander liegen.
5. Wasser und Wasserdampf für Reinigung, Desinfektion und Sterilisierung können Salze, Metalle und Minerale enthalten die Korrosion und Verfärbungen verursachen können. Kontrollieren Sie die Wasserqualität. Hartes Wasser muss enthärtet werden. Für die Schlusspülung des Instrumentes empfehlen wir demineralisiertes Wasser.
6. Folgen Sie immer den Anweisungen des Herstellers bei Verwendung von Desinfektions- und Reinigungsautomaten, sowie beim Spülmittel. Verwenden Sie ein Reinigungsmittel mit einem pH-Wert von 8 - 10,5. Dosierungsangaben des Herstellers beachten! Die Instrumente dürfen nicht länger als vom Hersteller angegeben in der Lösung liegen. Das Spülen sollte mit vollentsalztem Wasser erfolgen. Trocknen Sie das Instrument sofort.
7. Benützen Sie nur die für das Instrument vorgeschriebene Desinfektionslösung bei manueller Reinigung. Richten Sie nach den Anweisungen des Herstellers wegen Dosierung und Zeit. Die Instrumente dürfen nicht länger als vom Hersteller angegeben in der Lösung liegen. Spülen Sie am besten mit demineralisiertem Wasser. Trocknen Sie das Instrument hinterher.
8. Bei Ultraschallbehandlung muss das Instrument ganz in der Lösung und offen liegen. Beschichtete Instrumente dürfen nicht mit Ultraschall gereinigt werden. Spülen Sie mit demineralisiertem Wasser nach. Seien Sie sorgfältig beim Trocknen. Befolgen Sie die Anweisungen des Herstellers.
9. Kontrollieren Sie das Instrument auf Schmutz, Risse, Verfärbungen, Brüche und Korrosion.
10. Kontrollieren Sie jede einzelne Funktion des Instrumentes.
11. Bei der Reinigung verwenden Sie nur besondere für Instrumente geeignete Bürsten. Stahlwolle darf nie gebraucht werden. Es kann sonst zu Rissen und Eisenspänen auf dem Instrument kommen, was zur Korrosion führen kann.
12. Ölen Sie das Instrument leicht ein an Stellen, wo sich das Metall trifft (z.B. Scherenblätter, Box-Schlösser, Schrauben, Rasten) nach jedem Gebrauch. Die Einölung wird am besten vor der Sterilisierung vorgenommen. Wir empfehlen die Verwendung von Instrumentenöl von STILLE. Das Öl muss einen Entflammbarkeitsgrad von über 135 Grad Celsius haben. Trocknen Sie überflüssiges Öl auf, um schmierige Instrumente und Fettflecke auf den Steril-Verpackungen zu vermeiden.
13. Folgen Sie den Anweisungen des Herstellers sehr genau bei der Sterilisierung. Es ist wichtig das man die Instrumente nicht zu hart packt. Die

Instrumente sollen in offenem Zustand sterilisiert werden, damit der Dampf an alle Teile des Instrumentes kommt.

14. Wir empfehlen keine Heissluftsterilisierung. Die hohen Temperaturen schaden dem Metall.
15. H2 O2 Sterilisierung empfehlen wir nicht für schwarzverchromte Instrumente. Sie können flammig werden. Die Funktion wird dagegen nicht beeinträchtigt.
16. Neue Instrumente müssen gereinigt, kontrolliert, eingeölt und sterilisiert werden vor dem ersten Gebrauch.
17. Für Service und Reparaturen machen Sie nur von professionellen Reparateuren/Werkstätten Gebrauch. Z.B. müssen Super Cut-Scheren speziell geschliffen werden, damit die Schneide nicht zerstört wird. Bei falsch ausgeführter Reparatur/Service gilt nicht die STILLE-Garantie.

## Garantie

Wir übernehmen, auf Ausführung und Material von chirurgischen Instrumenten eigener Herstellung eine Garantie von 30 Jahren d.h., wir ersetzen oder reparieren kostenlos beschädigte Instrumente, bei denen die Ausführung oder das Material fehlerhaft ist. Diese Garantie erstreckt sich nicht auf den normalen Verschleiss. Die Garantieverpflichtung ist gültig unter der Voraussetzung, dass die Instrumente für vorgesehenen Zweck verwendet und fachgemäss gepflegt werden, sowie dass eingetretener Schaden uns innerhalb von 30 Tagen schriftlich mitgeteilt wird.

## Trattamento degli strumenti chirurgici

I seguenti consigli e prescrizioni permettono di ottenere le migliori prestazioni e una lunga durata degli strumenti chirurgici STILLE. La garanzia STILLE é valida solo se vengono rispettate le istruzioni indicate.

1. Trattare tutti gli strumenti chirurgici con cura, in particolare gli strumenti per microchirurgia.
2. Pulire lo strumento immediatamente dopo l'utilizzo, a mano o meccanicamente. Non permettere alle impurità di indurire sugli strumenti. Non utilizzare prodotti contenenti perossido di idrogeno per la pulizia di strumenti con cromatura nera (ad esempio forbici SuperCut).
3. Non lasciare gli strumenti in ambiente umido più di quanto sia necessario, ad es. in attesa di essere trasportati al centro di sterilizzazione. Usare soluzioni appropriate, non acqua.
4. Per evitare il rischio di corrosione per tensione, non sottoporre lo strumento a tensione meccanica: in stato chiuso o intricato con altri strumenti. Strumenti a cremagliera devono rimanere aperti. Posare gli strumenti leggeri sopra quelli più pesanti. Gli strumenti per microchirurgia vanno sistemati uno vicino a l'altro.
5. Acqua e vapore utilizzato per la pulitura, la disinfezione e nell'autoclave possono contenere sali, metalli e minerali, i quali possono provocare cor-

rosione e colorazioni. Verificare le caratteristiche dell'acqua. L'acqua che contiene una concentrazione troppo elevata di sali e di cloro deve essere filtrata e trattata. Si consiglia l'uso di acqua demineralizzata, soprattutto per la risciacquatura finale.

6. All'uso di prodotti per la disinfezione e la pulitura rispettare sempre le prescrizioni del produttore. Utilizzare un detergente con pH 8-10,5, dosaggio secondo le istruzioni del produttore. Non lasciare lo strumento nella soluzione più a lungo di quanto indicato dal fabbricante. Risciacquare, preferibilmente utilizzando acqua demineralizzata. Asciugare immediatamente.
7. Per la pulitura manuale usare unicamente soluzioni disinfettanti prescritte. Seguire attentamente le istruzioni per quanto riguarda la dose e la durata. Non lasciare gli strumenti nella soluzione più a lungo di quanto prescritto. Sciacquare con acqua demineralizzata e asciugare immediatamente.
8. Per la pulitura ad ultrasuoni lo strumento deve essere aperto e completamente immerso nella soluzione. Gli strumenti rivestiti non devono essere puliti ad ultrasuoni. Risciacquare con acqua demineralizzata e provvedere ad un'asciugatura completa e immediata.
9. Controllare che non ci siano residui, scalfitture, scolorimenti, fessure o macchie di corrosione sullo strumento.
10. Controllare il funzionamento di ogni strumento individualmente.
11. Usare unicamente spazzole morbide per strumenti - mai spugne o spazzole metalliche
12. Lubrificare lo strumento dopo ogni uso, nei punti di contatto tra le parti metalliche, immediatamente prima della sterilizzazione. Si consiglia olio STILLE per strumenti. In ogni caso si deve usare olio con punto d'infiammabilità superiore a 135 ° C. È sufficiente una goccia sulle superficie a contatto (filo delle forbici, cerniere ad incastro, fermagli, vite e tacche d'arresto). Rimuovere l'olio eccessivo per evitare strumenti grassi e macchie sul materiale d'imballaggio per l'autoclave.
13. Rispettare scrupolosamente le prescrizioni del costruttore degli sterilizzatori. Non imbappare troppo forte. Gli strumenti devono essere aperti durante la sterilizzazione, permettendo al vapore di raggiungere tutte le parti dello strumento.
14. Sconsigliamo sterilizzazione a secco. Temperature alte possono alterare la struttura del metallo.
15. La sterilizzazione con acqua ossigenata non é consigliabile per strumenti cromati di nero. Detta procedura non compromette la funzione, ma le superficie nere si scoloriscono.
16. Strumenti nuovi devono essere puliti, controllati, oliati e sterilizzati prima del primo uso.
17. Riparazioni e manutenzione devono essere eseguite da professionali. Per esempio le forbici Super Cut (una lama da forcice e una lama da coltello) devono essere affilate in modo speciale per non rovinare il filo. La garanzia STILLE non é valida per riparazioni effettuate in modo erraneo.

## Garanzia

Lo strumentario chirurgico della nostra propria produzione é coperto da una garanzia di 30 (Trenta) anni contro qualsiasi difetto di fabbricazione o di qualità del materiale usato. Ci impegniamo a ripararlo o a rimpiazzarlo a nostre spese, sempre se é un difetto di produzione o di materiale. La garanzia non copre il logoramento normale, neppure difetti dovuti a mancata manutenzione. Questo impegno é valevole a condizione che gli strumenti siano usati per lo scopo previsto e che siano custoditi e mantenuti in modo professionale, e che il reclamo per iscritto ci pervenga entro 30 giorni a partire dalla data di constatazione del guasto.

## Tratamiento del instrumental quirúrgico

Hemos desarrollado los siguientes consejos e instrucciones de mantenimiento para que Ud. obtenga el mayor rendimiento y duración de los instrumentos quirúrgicos de STILLE. Asimismo, el compromiso de garantía de STILLE sólo es válido si el instrumento se utiliza y cuida según las instrucciones indicadas a continuación.

1. Trate el instrumento con cuidado. Este punto es aplicable a todos los instrumentos en general y a los microinstrumentos en particular.
2. Limpie el instrumento, a mano o a máquina, tan pronto como sea posible tras su utilización. No deje secar partículas extrañas en el instrumento. No se recomienda ningún método de limpieza que contenga hidrógeno de peróxido para instrumentos de cromadura negra (ej: Tijeras SuperCut).
3. No conserve el instrumento en un ambiente húmedo más tiempo del necesario, por ej. mientras espera su transporte a la central de esterilización. Utilice únicamente los métodos adecuados para cada caso.
4. No deje los instrumentos en tensión, por ej. cerrados o enredados con otros instrumentos. En estos casos aumenta el riesgo de corrosión. Los instrumentos con cierre deben dejarse abiertos. Coloque los instrumentos más pesados debajo y los más ligeros encima. No coloque nunca los instrumentos microquirúrgicos unos encima de otros.
5. El agua y vapor de agua para la limpieza, desinfección y esterilización con autoclave pueden contener sales, metales y minerales que pueden provocar corrosión y manchas. Controle la calidad del agua. El agua dura debe ablandarse. Se recomienda el enjuague final del instrumento con agua desmineralizada.
6. Siga siempre las instrucciones del fabricante al usar productos desinfectantes y de limpieza. Utilice un detergente con un pH comprendido entre 8-10.5 a una dosis correcta según las instrucciones del fabricante. No almacene el instrumento en la solución por un tiempo mayor al indicado por el fabricante. Remoje, preferiblemente con agua desmineralizada. Seque el instrumento inmediatamente.
7. Al limpiar a mano, utilice únicamente soluciones desinfectantes adecuadas. Siga las instrucciones del fabricante en lo que respecta a dosificación y tiempo. No tenga el instrumento en la solución más tiempo del indicado por el fabricante. Enjuáguelo, preferentemente con agua desmineralizada. Seque el instrumento inmediatamente.
8. En caso de utilizar ultrasonido para la limpieza del instrumento, éste debe estar abierto y completamente cubierto con la solución de limpieza. Instrumentos con revestimiento no deben ser limpiados con ultrasonido (ej: instrumentos con niquelado). Enjuáguelo, preferentemente con agua desmineralizada. Séquelo cuidadosamente. Siga las instrucciones del fabricante.
9. Controle el instrumento para evitar la aparición de suciedad, rayas, manchas, estrías y corrosión.
10. Controle la función de cada instrumento por separado.
11. Utilice únicamente cepillos para instrumentos. No utilice nunca estropajos de acero.
12. Después de cada uso, ponga aceite en el instrumento en los lugares en los que el metal esté en contacto con metal. El mejor momento para poner aceite es justo antes de la esterilización. Utilice preferentemente el aceite para instrumentos de STILLE. El aceite debe tener un punto de inflama-

ción por encima de 135°C. Utilice el aceite con moderación en superficies que entran en contacto durante el uso (hojas, cierres y tornillos). Quite el aceite sobrante para evitar tener instrumentos grasientos y la aparición de manchas de grasa en el envase de esterilización con autoclave.

13. Siga las instrucciones del fabricante en la esterilización con autoclave. No coloque demasiados instrumentos a la vez. Durante la esterilización con autoclave, los instrumentos deben estar "abiertos" para que el vapor llegue a todos los rincones de cada instrumento.
14. No se recomienda la esterilización con aire caliente. Las elevadas temperaturas repercuten en el metal.
15. No se recomienda la esterilización con peróxido de hidrógeno para instrumentos de cromo negro. El color de estos instrumentos puede cambiar, aunque su funcionalidad no se vea afectada.
16. Antes de su primera utilización, limpie, controle, ponga aceite y esterilice todos los instrumentos nuevos.
17. Utilice únicamente un especialista/taller profesional para servicio y reparaciones. Por ej. las tijeras de Super Cut deben afilarse de modo especial, en caso contrario es fácil destruir la parte cortante. Si una reparación/servicio se realiza de modo incorrecto, la garantía de STILLE no es válida.

## Garantie

El instrumental quirúrgico de nuestra propia fabricación tiene una garantía de 30 (Treinta) años contra cualquier defecto de manufacturación o calidad del material empleado, obligándonos a reemplazarlo o repararlo sin cargo alguno, siempre que sea debido a defectos del material o de su fabricación. El desgaste normal por su uso, queda excluido de dicha garantía. Esta garantía queda condicionada a que el instrumental sea utilizado para la finalidad prevista siendo cuidado y conservado de acuerdo con nuestras instrucciones y debiendo comunicar su deterioro por escrito dentro de los 30 días a partir del mismo.

**DR. LARS LEKSELL**, professor i neurokirurgi vid Lunds universitet och Karolinska institutet, kirurg vid Serafimerlasarettet och Sundsvalls lasarett samt ledamot av Kungliga Vetenskapsakademien. Uppfann strålkniven Leksell Gamma Knife 1951. Utvecklade tillsammans med STILLE den mycket populära gougetången som bär namnet STILLE-Leksell.

**DR. LARS LEKSELL**, professor of neurosurgery at Lund University and the Karolinska Institute, surgeon at the Serafimer Hospital and Sundsvall Hospital and a member of the Royal Swedish Academy of Sciences. Inventor of the Leksell Gamma Knife in 1951. Developed in collaboration with STILLE the very popular gouge forceps bearing the name STILLE-Leksell.





## **STILLE Surgical Instruments**

Edition 2.3, October 2014

Photos: Åke Gunnarsson, Vue and Jonas Frid, Studio Roland

Copy: Maria Howard-Lindberg, Beep AB

Graphic design: Lena-Maria Trast, Formfarmen AB

Printing: Arkitektkopia AB

Paper on cover: Profi Silk 300g. Paper, inlet: Profi Gloss 130g

Printed in Sweden 2013. Article number: 950-01-03

© STILLE AB 2013



“Det var ett intensivt arbetsamt liv, som Albert Stille kunde blicka tillbaka på när han 1880 lämnade över den tekniska ledningen av sin firma till sonen Max. Från morgon till kväll var han på verkstaden och på kontoret, knappast unnande sig någon ro ens under måltiderna. Arbetet följdes av stor framgång tack vare hans gedigna kunskaper, hans utomordentliga skicklighet i yrket och hans konstnärssinne. När det gällde att finna på nya metoder och nya instrument svek aldrig hans intresse, och han lät sig ej avskräckas av någon svårighet.”

Ur “STILLE 1841-1941 – Återblick på en hundraårig verksamhet”

“It was a hectic working life that Albert Stille looked back on in 1880 when he handed over the technical management of the company to his son Max. From morning to night he was at the shop and in the office, scarcely allowing himself to rest even at mealtime. The work was followed by great success due to his extensive knowledge, his outstanding skill in the profession and his inventive mind. When it came to finding new methods and new instruments his interest remained strong, and he allowed himself not to be discouraged by any difficulty that arose.”

From “STILLE 1841-1941 - Flashback on a century of operation”

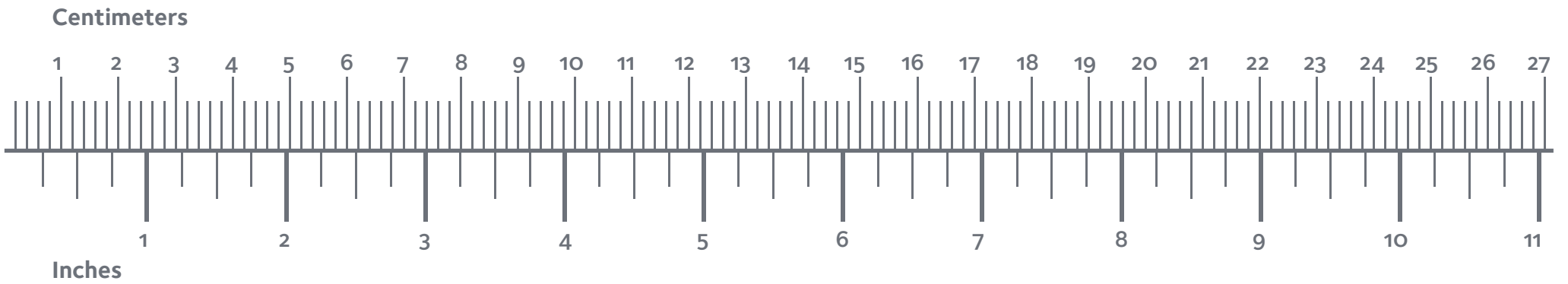



**HANTVERK HELA VÄGEN.** Att skapa kvalitetsinstrument är ett hantverk hela vägen – från instrumentmakaren till kirurgen. Passionen, yrkesskickligheten och fingertoppskänslan har de gemensamt. Och genom deras nära samarbete vidareutvecklas instrumenten. Sortimentet är specialiserat på tre områden – plastikkirurgi, ortopedi samt klassiska STILLE-instrument för flera olika kirurgiska discipliner. Gediget hantverk, suverän funktion och överlägsen kvalitet är de unika instrumentegenskaper som gör att STILLE efterfrågas av kirurger över hela världen.



**CRAFTSMANSHIP ALL THE WAY.** Creating quality instruments is an art form every step of the way – from the instrument maker to the surgeon. Passion, professionalism and flair are common attributes. And through their close collaboration these precision instruments are fine-tuned and developed further. The product range is specialized in three areas – plastic surgery, orthopedics and classic STILLE instruments for various other surgical disciplines. True craftsmanship, outstanding performance and superior quality are the unique characteristics that make STILLE the hands down choice of surgeons worldwide.



Surgical Perfection. For life.

#### STILLE AB

Gustav III:s Boulevard 42  
SE-169 73 Solna, Sweden  
Phone: +46 8 588 580 00  
Fax: +46 8 588 580 05  
info@stille.se

[www.stille.se](http://www.stille.se)

#### STILLE Surgical Inc.

943 Parkview Blvd  
Lombard, IL 60148  
United States  
Phone: 1.800.6651614

Pris: 200 SEK | Price \$30

#### Distributed by: